



# UNITED STATES COAST GUARD

---

**REPORT OF INVESTIGATION INTO THE  
CIRCUMSTANCES SURROUNDING THE MULTIPLE  
RELATED MARINE CASUALTIES AND  
GROUNDING OF THE**

## **MODU KULLUK**

**ON DECEMBER 31, 2012**



MISLE ACTIVITY NUMBER: 4509675



16732  
April 2, 2014

**REPORT OF INVESTIGATION INTO THE CIRCUMSTANCES SURROUNDING THE  
GROUNDING OF THE MOBILE OFFSHORE DRILLING UNIT (MODU) KULLUK ON  
THE EASTERN COAST OF SITKALIDAK ISLAND, ALASKA  
ON DECEMBER 31, 2012**

**ACTION BY THE COMMANDANT**

The record and the report of the Formal Investigation convened to investigate the subject casualty have been reviewed. The record and the report, including the findings of fact, analysis, conclusions, and recommendations are approved subject to the following comments.

**COMMENTS ON THE REPORT**

1. While the Investigating Officer correctly identifies a multitude of specific factors that contributed to the casualty in his report, I agree with the District 17 Commander that the inadequate assessment and management of risks by the parties involved was the most significant causal factor of the mishap. Vessels and the operations they conduct are growing more complex, and the risks that accompany these operations increase, whether in Alaskan waters or not. The failure to adequately understand, respect, and not complacently assume past practice will address new risks, is critical both in practice and in company culture. In this case, the risks associated with a single vessel tow by a new purpose-built vessel of a unique conical-shaped hull, with people aboard, in winter Alaskan waters where weather systems and seas are expected to rapidly develop, were extremely high. The consequences of inadequate management of risks impacts all operators, not just the specific company or party involved. Industry, vessel classification societies and regulators have a responsibility to ensure risks are properly addressed, even where the establishment of standards lag industry technological or operational developments.
2. I am most troubled by the significant number and nature of the potential violations of law and regulations identified in the Enforcement section of the investigative report, including the failure to report marine casualties, failure to report safety-related vessel issues, and improper/illegal bridge and engineroom watch-keeping systems [Civil Penalty Finding 1, page 116]. I am additionally troubled by the potential evidence of negligent conduct by master, chief engineer, and third mate aboard the anchor-handling Offshore Supply Vessel M/V AIVIQ [Suspension and Revocation Findings 1 – 4, pages 116-117]. I will ensure that these potential violations are thoroughly investigated by the Officer in Charge, Marine Inspection, Western Alaska, and as applicable, at other Coast Guard Sectors. If an operator fails to notify class, the Coast Guard, and other stakeholders of casualties and/or hazardous conditions as required, there is a high probability appropriate risk mitigation actions will not be taken, and in the case of the KULLUK, with great consequence. If it is found that violations of law and regulations occurred in a company with a valid Safety Management System in place, it is of special concern. A Safety

Management System “must document ... (1) Safety and pollution prevention policy; (2) Functional safety and operational requirements; (3) Recordkeeping responsibilities; and (4) Reporting responsibilities” as noted in Part 33 of the Code of Federal Regulations, subpart 96.220. It is the primary responsibility of the crew and the operating company to ensure compliance with the minimum standards established by classification society rules and international or domestic requirements, and a company’s Safety Management System is its attestation of their safety and environmental protection policies. A Safety Management System cannot be an administrative exercise detached from a company’s true safety culture. If the potential violations of law and regulations noted in the report actually occurred, far greater levels of oversight will be required.

### **ACTION ON RECOMMENDATIONS**

As a result of the investigation, eight safety recommendations were issued. The District 17 Commander’s response to Recommendation #2, which was addressed to him, is noted and action on that recommendation is considered completed at the District level. The following is the Commandant’s Action in response to the remaining seven safety recommendations.

Recommendation 1: It is recommended that the Commandant partner with the Towing Safety Advisory Council (TSAC) to establish a working group to draft and accept a Task Statement addressing, but not limited to the issues raised by this marine casualty, the towage of MODU's in the arctic marine environment and the following:

- a. The study and prescribed standards for ocean tows of MODU's to include inspection and non-destructive testing of towing equipment prior to tows.
- b. The process of issuing and tracking certificates that accompany towing hardware to include identifying a particular component by a standardized tracking method.
- c. A detailed review of towing configurations and tow escorts for MODU ocean tows and development of tow plans in the most effective manner.
- d. Evaluate the practice of logging ocean towing operations for MODU's or vessels of a similar nature. Determine the effectiveness of a log being kept detailing the history of each item of the towing equipment utilized for the MODU tow. This includes shackles, towing plates, connector links, bridge chains, pendant wires and other towing connections.
- e. Evaluate usage and application of strain monitoring devices equipped on towing vessels to determine the recommended procedures to reduce the likelihood of towing equipment failures.

Action: I concur with this recommendation. I agree that the issues identified in this recommendation should be addressed by the Towing Safety Advisory Committee (TSAC) and will ensure that this recommendation is considered for presentation at an upcoming TSAC meeting with an associated task statement issuance. It is noted that the first issue listed in the recommendation, the standards for ocean tows of MODU’s, is already incorporated in a current tasking of the TSAC Subcommittee on Towing Gear.

Recommendation 3: It is recommended that Coast Guard District 17 evaluate the existing towing equipment aboard its medium and high endurance cutter and icebreaker fleet to determine its existing towing practices and equipment capabilities. Upon conclusion of this assessment the District should evaluate the equipment to determine if the fleet can upgrade towing capabilities and equipment for USCG vessels that will operate in the 17th Coast Guard District.

Action: I partially concur with this recommendation. Like the District 17 Commander, I agree that it is appropriate to evaluate the effectiveness of towing equipment aboard the cutter fleet. However, I also agree with his follow-on recommendation that it should be the Surface Forces Logistics Center (SFLC), not District 17, who should conduct the evaluation of the equipment capabilities for vessels that operate in District 17 and upgrade towing capabilities and equipment as appropriate. Finally, I agree with the District 17 Commander's additional recommendation that FORCECOM evaluate the existing towing practices to determine the need for updated/standard towing practices. A copy of this report will be sent to SFLC and FORCECOM asking that they conduct the recommended evaluations and implement any resulting updates to equipment and standards, as appropriate. Additionally, a copy of this report will be sent to the Coast Guard Assistant Commandant for Capabilities.

Recommendation 4: Shell and any Corporation or Entity Intending to Work in the Arctic Marine Environment develop and maintain policies and guidance that addresses all aspects of marine operations to include tow planning for operations across the globe, and establish additional criteria for operations that take place in areas of historical heavy weather, such as the Alaskan theatre.

Shell should consider criteria for:

- a. Tow Routing
- b. Suitability of towing vessels, including an emphasis on installation and usage of tow strain monitoring equipment, bollard pull capabilities taking into account expected environmental conditions, and availability of towing procedures and policies tailored to each individual tow
- c. Contingency planning including harbors of safe refuge
- d. Towing equipment sized and configured for anticipated environmental forces
- e. Acceptable 3rd Party assessments of operations prior to towages, scope to include all aspects of towage

Recommendation 5: Edison Chouest Offshore or any marine company intending to work in the arctic regions should reevaluate operating procedures for vessels operating in the Gulf of Alaska or similar environments, specifically to ensure that they develop towing procedures, policies, guidelines, checklists and job safety aids for towing operations that would be conducted by vessels in its fleet. These procedures should include the full use of the capabilities of strain monitoring devices if installed. These towing procedures should be included in the Safety Management System (SMS) for ECO vessels.

Action: I concur with recommendations #4 and #5. I will have a Lesson's Learned published based on the findings of this investigation that addresses the issues raised in these two recommendations and present them to all parties who are conducting, or may be considering, operations in the Arctic Marine Environment.

Recommendation 6: Edison Chouest Offshore should ensure critical fuel oil management and towing procedures are developed and included in the Safety Management System (SMS) for the AIVIQ.

Recommendation 7: Edison Chouest Offshore should establish levels of competencies and formal training requirements for Masters and Mates engaged in towing. This may involve the use of simulators to provide realistic training. Consideration should be given for developing a training program and syllabus at the Edison Chouest Offshore Training Center specifically for towing operations.

Recommendation 8: Working with the Coast Guard and ABS, Edison Chouest Offshore should address all potential design engineering deficiencies noted in this report relating to the AIVIQ, particularly those items addressed in the Coast Guard Marine Safety Center Analysis included as Appendix 1.

Action: I concur with Recommendations #6, #7, and #8. I am providing a copy of this Report of Investigation to Edison Chouest Offshore and will urge them to review its findings and those of the Coast Guard Marine Safety Center's analysis and to take appropriate action in response to these recommendations.



JOSEPH A. SERVIDIO  
Rear Admiral, U.S. Coast Guard  
Assistant Commandant for Prevention Policy



16732

29 JAN 2014

## MEMORANDUM

From: [REDACTED]  
F. P. OSTEBO, RADM  
CGD SEVENTEEN (d)

To: COMDT (CG-INV)

Subj: MODU KULLUK MARINE CASUALTY INVESTIGATION

Ref: (a) Title 46, United States Code (USC), Chapter 63  
(b) Title 46, Code of Federal Regulations (CFR), Subpart 4.07  
(c) My memo 16731 of 4 Jan 2013, Convening Order

1. Pursuant to references (a) and (b), I convened a one-person formal investigation into subject casualty as detailed in reference (c). The investigation and corresponding MISLE activity (# 4509765) are forwarded for final review. I approve the findings of the investigation and recommend that the investigation be officially closed. I concur with the majority of the conclusions as discussed below and indicate my action on those recommendations that are specific to the District.
2. A complex series of events contributed to the error chain that resulted in the grounding of MODU KULLUK. The most significant factor was the decision to attempt the voyage during the winter in the unique and challenging operating environment of Alaska. Shell and Edison Chouest Offshore's ineffective risk management and application of towing measures for the voyage also contributed to the grounding.
3. While I agree with the conclusions made in the formal investigation report, I feel that an inadequate determination of risk occurred, demonstrating a lack of respect for the unique risks inherent in Alaskan operations.
4. The AIVIQ experienced several marine casualties that were not properly reported to the Coast Guard in the required time frame. These incidents are currently under investigation by Sector Anchorage. Knowledge of the mechanical and design issues prior to receipt of the tow plan may have changed the review process and raised more questions regarding the suitability of the AIVIQ as a single vessel tow for the KULLUK.
5. While it is reasonable to factor in a Coast Guard response by staying less than 200 miles offshore, it would have been more prudent to determine the route based on best time/speed/distance/weather analysis. Given the forecast, this could have resulted in KULLUK being towed on a great circle route in favorable weather which may have prevented the incident. At the very least, the greater distance would have allowed additional time to respond to the incident with appropriate resources, which could have prevented the grounding.

## 6. Safety Recommendations:

- a. Recommendation #1: Concur in part. I agree that there could be benefit with this recommendation through a Towing Safety Advisory Council (TSAC) working group focusing on enhancements to tow gear, tow arrangements and tow monitoring for MODUs. I believe sufficient industry standards and controls existed for this towing evolution and if they had been followed or applied, the grounding of the KULLUK could have been avoided.
- b. Recommendation #2: Do not concur. I believe there is adequate flexibility in the current regulatory framework to monitor and provide sufficient controls to these operations. Aside from the potential regulatory rulemaking procedures such criteria would require, the envisioned environmental, personnel and equipment dynamics would be too varied to refine into a policy of minimal criteria.
- c. Recommendation #3: Concur in part. I agree that further evaluation of towing equipment aboard the medium and high endurance cutter and icebreaker fleet would help define towing practices and equipment capabilities. However, District 17 does not have logistical control over most cutters that operate in the Arctic. I recommend that Surface Forces Logistics Center (SFLC) evaluate the equipment capabilities for vessels that operate in District 17 and upgrade towing capabilities and equipment as appropriate. Additionally, FORCECOM should evaluate the existing towing practices to determine the need for updated/standard towing practices throughout the fleet. This process appears to be underway, as SFLC has a Time Compliance Technical Order (TCTO) with USCGC ALEX HALEY for the prototype testing of a High Molecular Weight Polyethylene (HMWPE) primary towing hawser replacement for the existing double-braided nylon primary towing hawser and improperly sized Proton-8 (Dyneema) high-strength hawser.
- d. Recommendation #4: Concur. However, this should be industry implemented.
- e. Recommendations #5 through #8: Concur. Mariners who have experience working offshore in the Gulf of Mexico do not necessarily possess the knowledge of the unique hazards that exist in the Gulf of Alaska. Edison Chouest Offshore or any marine company intending to work in Arctic regions should develop specific operating procedures, policies, guidelines, checklists, and job safety aids for any operations taking place in Alaska to provide crew with appropriate knowledge.

## 7. Enforcement Recommendations:

- a. I concur that the investigation indicates potential violations of U.S. laws and regulations regarding the reporting of marine casualties and hazardous conditions by Edison Chouest Offshore and MV AIVIQ. It appears that some of the potential violations occurred outside the timeframe of this casualty. The Officer in Charge Marine Inspection (OCMI), Western Alaska is inquiring into this issue and will take appropriate enforcement action upon completion of those investigations.

- b. I concur that there is evidence that the Chief Engineer of AIVIQ may have committed acts of misconduct or negligence. The OCMI, Western Alaska is conducting further investigation to determine appropriate enforcement action.
- c. I concur that there is evidence that the Master of AIVIQ may have committed acts of misconduct or negligence. The OCMI, Western Alaska is conducting further investigation to determine appropriate enforcement action.
- d. I concur that there is evidence that the 3<sup>rd</sup> Mate of AIVIQ may have committed acts of misconduct or negligence. The OCMI, Western Alaska is conducting further investigation to determine appropriate enforcement action.
- e. I concur that the investigation indicates potential violation of U.S. laws or regulations regarding personnel watch requirements. The OCMI, Western Alaska is conducting further investigation to determine appropriate enforcement action.

8. Commendable Acts. I concur in the recommendations and approval of appropriate recognition upon conclusion of this investigation.

9. As noted in the report, a number of Parties-in-Interest (PII) were designated and provided considerable background and technical information through the course of this investigation. Some of that information is reproduced in the report. I recommend that a copy of the final Report of Investigation be shared with each PII so that they may review and comment on the information contained prior to public release so that any concerns over proprietary information may be addressed.

10. In addition to the actions being taken above, I am directing that each Marine Inspector within District 17 review the Report of Investigation in preparation for the 2014 Arctic drilling season. Familiarity with the equipment deficiencies on AIVIQ identified in this investigation and other ongoing investigations by Sector Anchorage will ensure that such deficiencies are corrected and verified prior to AIVIQ's use in planned Chukchi Sea operations.

#

Encl: (1) MODU KULLUK MARINE CASUALTY INVESTIGATION

Copy: PACAREA with enclosures  
Sector Anchorage w/o enclosures  
CDR J. D. McTaggart w/o enclosures



(This Page Intentionally Left Blank)

U.S. Department of  
Homeland Security

United States  
Coast Guard



United States Coast Guard  
Investigations National Center of  
Expertise

1615 Poydras Street  
Suite 1030  
New Orleans, LA 70112  
Phone: (504) 589-2110  
Fax: (504) 589-4244

16731  
3 Dec 2013

## MEMORANDUM

From: J. D. McTaggart, CDR [REDACTED]  
Investigations National Center of Expertise

To: T. P. Ostebo, RADM  
CGD SEVENTEEN (d)

Thru: CGD SEVENTEEN (dp)  
CGD SEVENTEEN (dl)  
CGD SEVENTEEN (dcs)

Subj: MODU KULLUK MARINE CASUALTY INVESTIGATION

Ref: (a) Your memo 16731 of 5 Jan 2013  
(b) Title 46 U.S. Code Section 6301 et seq.  
(c) Title 46 Code of Federal Regulation, Part 4  
(d) Marine Safety Manual Vol. V: Investigations and Enforcement,  
COMDTINST M16000.10A

1. In accordance with reference (a), you designated and directed me to conduct a formal investigation into the multiple related marine casualties and grounding of the MODU KULLUK that occurred on December 31, 2012. Mr. [REDACTED] was assigned as my assistant and LCDR [REDACTED] was assigned as legal counsel. In accordance with reference (b), and with the assistance of LT [REDACTED] serving as recorder, a public hearing was held. In accordance with reference (c), we were able to gather facts, conduct interviews, perform analysis, draw conclusions and make recommendations regarding the casualty. Mr. [REDACTED] of the Coast Guard Marine Safety Center, Ms. [REDACTED] of the Bureau of Safety and Environmental Enforcement (BSEE), Dr. [REDACTED] of the National Transportation Safety Board (NTSB) and personnel from Sector Anchorage offered considerable assistance to this investigative effort.
2. All evidence, correspondence and testimony gathered during the investigation and used to create this report will be included in the Coast Guard's Marine Information System for Law Enforcement (MISLE) electronic database under Incident Investigation Activity Number 4509675.

#

Encl: (1) MODU KULLUK Marine Casualty Report of Investigation (ROI)

## Table of Contents

EXECUTIVE SUMMARY.....	1
FIGURE 1 – SIGNIFICANT EVENT TIMELINE OVERVIEW.....	6
COMMONLY USED ACRONYMS.....	7
VESSEL DATA.....	9
INVOLVED VESSEL PERSONNEL AND OTHER PERSONNEL INTERVIEWED.....	15
PARTIES IN INTEREST.....	16
FINDINGS OF FACT .....	17
ANALYSIS.....	70
CONCLUSIONS.....	110
SAFETY RECOMMENDATIONS.....	114
ENFORCEMENT.....	116
COMMENDABLE ACTS.....	117
APPENDIX 1.....	118

**EXECUTIVE SUMMARY:**

At approximately 1430<sup>1</sup> on December 21, 2012 the Mobile Offshore Drilling Unit (MODU) KULLUK departed Captains Bay, Alaska under tow for a voyage to the Seattle, Washington area. The ice classed<sup>2</sup>, anchor handling tug supply vessel AIVIQ was the single towing vessel employed for this towing evolution. The towing operation consisted of a voyage of more than 1,700 nautical miles across the northern region (Coastal Route) of the Gulf of Alaska during the winter months. The voyage began after a routine departure, encompassing assistance from multiple towing vessels and onshore personnel. The guidelines and procedures for this critical towing operation were contained in the *Shell Tow Plan, KULLUK Tow Plan: Captains Bay, Unalaska to Port Angeles Pilot Station, dated December 21, 2012*.<sup>3</sup> The Shell Marine Manager located in Shell's Anchorage offices, developed the plan and was the lead shore side management team member overseeing the offshore towing operations.

The KULLUK was registered in the Republic of the Marshall Islands. Its crew complement at the time of the incident consisted of 18 persons, exceeding the manning requirements as determined by the Republic of Marshall Islands and listed on the issued minimum safe manning certificate. A non-self-propelled vessel completed in 1983, the KULLUK relied on the towing vessel for its movements from location to location. Additionally, KULLUK had a unique conical-shaped hull with no obvious bow or stern and little directional stability when under tow. Aboard the KULLUK the Offshore Installation Manager (OIM) had overall responsibility for the KULLUK and personnel embarked aboard. The Shell Tow Plan also included a Tow Master that supervised the towing operation aboard the KULLUK while the tow was underway.

The towing vessel AIVIQ was a multi-purpose vessel designed and built exclusively for supporting the operations of the KULLUK in the Arctic region's harsh maritime environment. Delivered in 2012, AIVIQ was equipped with a state of the art bridge navigation suite, propulsion and towing system. The AIVIQ Master was responsible for the safety of the tow once the tow hawser was secured to the KULLUK and the vessel was underway.

After departure on Friday December 21, AIVIQ utilized the established safety fairways and towed the KULLUK to the north of the Krenitzin Island group before turning and clearing Unimak Pass.

Reaching the open waters of the Gulf of Alaska at approximately 1600 on December 22, AIVIQ increased the length of the towing hawser to approximately 1700 feet. KULLUK was being towed on the rig's primary towing configuration. The AIVIQ tow hawser was connected to a segment of surge chain, followed by the towing pennant. This pennant was connected to a shackle and then to the towing plate. Shackles connected the towing plate to chain bridles, which were secured on the "bow" of the KULLUK with Smit brackets.

During the voyage on December 22, the AIVIQ Master and Tow Master became concerned about the forecasted weather ahead of the tow. They informed the Shell Marine Manager and requested a course change to a more direct route towards the eastern side of the Gulf of Alaska to minimize the impact of the weather. Their request for a change in course was not formally

---

<sup>1</sup> All times in 24 hour time format and in Alaska Standard Time (AKST), which observes standard time by subtracting nine hours from Coordinated Universal Time (UTC-9).

<sup>2</sup> Ships that are classified as "ice classed" have a hull that has been strengthened and other design components to enable them to operate in sea ice.

<sup>3</sup> The Shell Tow Plan is a planning document produced for the December 2012 towing operation. In addition to the aforementioned plan, the unmooring operation was covered in the plan titled, *Operations Procedure CDU Kulluk Move from OSI Terminal Captains Bay Alaska to Pilot Station Broad Bay, Dated December 18 2012*.

granted, even though the Shell Tow Plan gave the AIVIQ Master and Tow Master the discretion to make course changes and alterations based on certain considerations.

On Tuesday morning, December 25, the #2 main diesel engine (MDE) began developing a leak in the oil pan, resulting in a slow loss of lubricating oil. This situation was closely monitored by the engineers, requiring the shutting down of the engine to check levels.

On the morning of Thursday, December 27, AIVIQ's towing winch control system<sup>4</sup> began generating numerous alarms, indicating high tension for the main towline. High tension was also noted by the crew by viewing the catenary of the towline. At 0600, the KULLUK logged the weather as east and southeast winds at 20-25 knots, seas 20 feet, pitch 8-10 degrees, roll 8-10 degrees, and a speed of advance at 3.8 knots. Responding to the situation, the AIVIQ officers paid out more towing hawser and reportedly slowed the vessel.

At approximately 1135, the towing operation experienced a failure of the towing shackle. The KULLUK was reported adrift at 56° 15' N and 152° 24' W. Examination of the towing equipment revealed a 120 ton shackle that connected the AIVIQ pennant wire to the triangular towing plate was missing and was not recovered. The SHELL Marine Manager was informed of the towing gear failure. SHELL notified the tug vessel GUARDSMAN and oil spill response vessel NANUQ, both located in Seward, Alaska, to make preparations to get underway. The USCG received notification by VHF radio at 1324 on December 27, and dispatched the USCGC ALEX HALEY<sup>5</sup> on patrol to proceed to assist.

The SHELL Tow Plan called for an emergency tow line to be in place aboard the KULLUK and preparations were being made to deploy it. The attachment point for that system was at the "stern" of the KULLUK beneath the helicopter deck. Onboard cranes could not be used to reconnect the main towing equipment due to the motion characteristics of the KULLUK being outside the safe operating parameters of the cranes.

Shortly after noon, AIVIQ made an approach to begin receiving the emergency tow line from the KULLUK. During the approach, AIVIQ took a heavy roll in the seaway. This roll caused a large steel device (called a "J-hook") to break loose from the upper deck, causing damage to its storage area. The ship's crew onboard the AIVIQ responded and welded that device to the deck as a means to secure it. The AIVIQ made another approach and at 1445 successfully connected her towing gear to the KULLUK's emergency tow line.

At 1430, the KULLUK was under tow once more. As the seas increased, AIVIQ towed the KULLUK further offshore and away from an eight fathom<sup>6</sup> shallow spot. The KULLUK's 10.7 meter draft, coupled with the harsh sea conditions, made that location a potential grounding spot.

At 2253, AIVIQ experienced the first in a series of serious engine casualties that started after the #2 MDE was secured to check lube oil levels.<sup>7</sup> The AIVIQ is equipped with electric thrusters, one swing down and four tunnel type thrusters. During the next several hours, the AIVIQ

---

<sup>4</sup> A sophisticated towing winch computerized control system that contains an alarm function that would monitor tension, length and other alarm parameters. The system has audible and visual alarms that require intervention to silence them.

<sup>5</sup>The U.S. Coast Guard Cutters Hickory and Spar would also play a limited role in the KULLUK response efforts.

<sup>6</sup> Fathom, a unit of measurement, 1 fathom equals 6 feet.

<sup>7</sup> The #2 main diesel engine had a lube oil leak in the oil pan requiring frequent monitoring of the lube oil engine.

experienced the loss of all of the other MDEs<sup>8</sup>. Using its swing down thruster and tunnel thrusters, the AIVIQ was unable to make headway and was pulled astern by the KULLUK.

At midnight on Friday, December 28, the KULLUK reported southwest winds at 25-30 knots, seas 14-17 feet with occasional 20 foot seas, and pitching 8-10 degrees with occasional 15 degrees. The USCGC ALEX HALEY arrived on scene at 0131 and assessed the situation. USCGC ALEX HALEY made an attempt to establish tow and take the AIVIQ towing the KULLUK in tow. The attempt was unsuccessful, as USCGC ALEX HALEY suffered a fouling of the port propeller shaft with the messenger and tow line.

During this period, AIVIQ's engineers were making repairs to the main engines while shore support was locating and assembling spare parts to effect repairs onboard. Using spare injectors onboard the vessel, the #1 MDE was returned to service, augmenting the thrusters. At 1115, USCGC ALEX HALEY departed for Kodiak, Alaska to effect inspection and removal of the fouled line from the port propeller shaft.

The tug GUARDSMAN arrived on scene at 1329 and began working with the AIVIQ and KULLUK to determine the best towing configuration for the KULLUK. The GUARDSMAN connected her hawser to the bow emergency towing bit on the AIVIQ, providing assistance to the towing of the KULLUK. At 1538, the GUARDSMAN had the AIVIQ in tow, towing the KULLUK all in one line astern. Despite this configuration, the GUARDSMAN was unable to make way with both vessels in tow and as pulled slowly astern, generally toward the northwest.

By afternoon, discussions were underway about the evacuation of the KULLUK by rescue helicopters. The Unified Command in Anchorage, Alaska was developing evacuation plans and steps to properly secure the KULLUK. By the early evening hours, the Unified Command Center was formally established at a hotel in downtown Anchorage, Alaska, having transitioned there from SHELL's headquarters in Anchorage. Shortly after 2300, U.S. Coast Guard MH-60 Jayhawk helicopters arrived on scene to attempt a night time evacuation of the 18 persons onboard the KULLUK. This evacuation attempt was unsuccessful due to the effects of the wind and the approach angle to KULLUK's helicopter deck. To affect night time rescue, rescue helicopters would have to approach the helicopter deck with the massive derrick just downwind from the approach patch. Pilots reported that the KULLUK was rising and falling approximately 50 feet during these attempts.

At some point during the late evening hours of December 28, the KULLUK's 15 long ton survival anchor was dropped to an undetermined depth below its hull. The dropping of this anchor was explained as the result of a miscommunication by personnel aboard the rig. There was a discussion with the KULLUK personnel and the USCG helicopters pilots on the use of the anchor to change the orientation of the KULLUK to allow for a safer approach. Due to the inherent danger, the night time evacuation attempt was cancelled.

At 2300, the GUARDSMAN reported they were being set towards Sitkinak Island with SE winds of 35-45 knots and seas 4-6 feet with a confused underlying swell ranging up to 20 feet from the southeast and south. On December 29, the tug ALERT, located in Port Etches, Alaska, was instructed to depart for the offshore location of the KULLUK towing operation, and at 0425, departed for sea.

At approximately 0510 on Saturday, December 29, the GUARDSMAN tow wire parted under the extreme weather conditions. The AIVIQ was once again towing on the emergency towline

---

<sup>8</sup> The AIVIQ had four main diesel engines driving two propeller shafts each equipped with controllable pitch propellers.

with limited propulsion power available. Sometime after the GUARDSMAN tow wire parted, the KULLUK again deployed the survival anchor; the time for this deployment is unknown. The OIM reported that the anchor was deployed to a significant depth and it drug along the ocean floor and did not catch the bottom. The survival anchor was recovered later that morning. Shortly after 0530, the NANUQ arrived on scene from Seward, Alaska. The Tow Master and the OIM aboard the KULLUK, working with the NANUQ and AIVIQ devised a plan to use a mooring/anchor wire onboard the KULLUK as an emergency tow line. The KULLUK was equipped with 12 heavy winch-mounted wires. The #8 wire was selected due to its location on the perimeter of the KULLUK in relation to the attachment point of the emergency tow line. The #8 wire would be paid out to a length of 1800 feet when made up to the NANUQ.

As the towing operations continued offshore, AIVIQ shore side support personnel delivered spare engine parts to USCG Air Station Kodiak. U.S. Coast Guard MH-60 Jayhawk helicopters delivered 12 baskets of spare parts to the AIVIQ. These parts included the fuel injectors and other associated parts. The delivery of these critical parts to the AIVIQ allowed the main propulsion plant of the AIVIQ to return to full operational status.

At 1150, the NANUQ stretched out her towing hawser after connecting to the KULLUK's #8 mooring wire. The AIVIQ, situated on the port side of the leg, was towing the KULLUK on a combination of the AIVIQ tow wire made fast to the synthetic emergency tow line.

At approximately 1200, the KULLUK's survival anchor was retrieved and stored in the hull. Evacuation of the rig by U.S. Coast Guard MH-60 Jayhawk helicopters commenced at 1235 on December 29 in approximate position 56° 39.6' N and 153° 29.0' W. Each helicopter flight required hoists using the rescue basket to take one person off the deck at a time in deteriorating weather conditions. The helicopter evacuation required three flights with each helicopter hoisting six persons aboard.

At 1335, the evacuation was complete without incident. The KULLUK was now unmanned under tow in position 56° 36.0' N and 153° 29.7' W.

The AIVIQ and NANUQ continued to tow the KULLUK for the rest of December 29 and into Sunday, December 30. Late in the morning of December 30, the AIVIQ reported SSW winds of 40-50 knots and seas of 20-25 feet with occasional 30 foot seas. At 1315, the NANUQ's tow hawser parted and shortly thereafter the emergency towline of the KULLUK parted near a spliced eye. The KULLUK was again adrift, in position 56° 15.3' N and 153° 24.9' W, approximately 30 miles from land and shoal water.

The tug ALERT arrived in the vicinity of the KULLUK at 1325, and made an initial attempt to connect a towline to the KULLUK. The attempt was unsuccessful due to the weather and the clutter of the various lines and towing equipment in the water in the vicinity of KULLUK's hull. The ALERT stood by awaiting another opportunity to connect the tow and the crew examined other possible towing options. At 1630, the AIVIQ returned to full propulsion capability with the repair of all MDEs. The AIVIQ crew examined available towing options and determined that the best course of action was to attempt the retrieve the 1800 foot section of the #8 mooring wire, which was still connected to the KULLUK and dragging behind the vessel. To accomplish this task, the AIVIQ departed the local area at 1930 to seek sheltered water off Sitkinak Point, approximately 20 miles away. The AIVIQ crew would need the protected water to shift the heavy steel grapple anchor from a storage location on the upper decks to the main deck and secure it to the towing equipment for the retrieval operation. At 0020 on Monday, December 31, the grapple was over the stern of the vessel, and at 0031 the AIVIQ left the shelter of the protected waters to proceed to the KULLUK's location.

At 0110, the ALERT successfully made her towing equipment fast to a bowline knot tied by the ALERT crew at the end of the KULLUK's emergency towline. The KULLUK was now under tow in position 56° 47' N and 153° 08' W. Once connected, the ALERT proceeded to tow the KULLUK away from shore. Returning to the vicinity of the KULLUK at 0357, the AIVIQ set up to use the grapple anchor to snag the mooring wire trailing off beneath the KULLUK. The AIVIQ captured and retrieved the #8 mooring wire in the first pass.

Once the #8 mooring wire was on the AIVIQ deck, it was made fast to the pennant wire. At approximately 0510, the ALERT and AIVIQ had the KULLUK undertow. Both vessels towed the KULLUK toward Port Hobron, a safe harbor on the northeast side of Sitkalidak Island.

At 1131, the tug GUARDSMAN was released from standby duty in vicinity of the KULLUK, having experienced a problem with its starboard reduction gear. She departed the area enroute to Sitkalidak Strait and sheltered waters.

Shortly after noon, the Unified Command decided to take advantage of a weather window to put a four person salvage team onboard the KULLUK. At 1336, a U.S. Coast Guard MH-60 Jayhawk helicopter lowered the team on the KULLUK via hoist while they attempted to make a salvage survey of the vessel. Weather conditions precluded carrying out this survey and a U.S. Coast Guard MH-60 Jayhawk helicopter retrieved the team without incident at 1448.

Under worsening weather conditions, the tow being set by the sea and the wind, AIVIQ's pennant wire parted at 1624. Winds from the southeast were reported at 40-50 knots, with seas at 20-25 feet and building. Following the failure of the AIVIQ's towline, and despite running the engines at full power, the ALERT continued to be pulled astern by the KULLUK.

As the weather continued to worsen and the KULLUK continued to drift towards shore, the ALERT attempted to influence the grounding location of the KULLUK. Oceans Bay, Alaska was considered a good location due to the nature and composition of the shoreline. It provided a gradually sloping gravel beach as a grounding location. At the Unified Command, discussions were ongoing about the time at which the ALERT would release the tow.

At 2000, the Unified Command instructed the ALERT to release the tow based on concerns for the safety of personnel aboard the vessel. At 2010, the ALERT reported they released the tow in position 57° 03.9'N and 153° 01.06'W, with the KULLUK approximately 3 miles from shore.

At approximately 2055, the KULLUK grounded on a stretch of shoreline near Oceans Bay, Alaska. There were no reports of significant pollution or injuries related to the grounding.

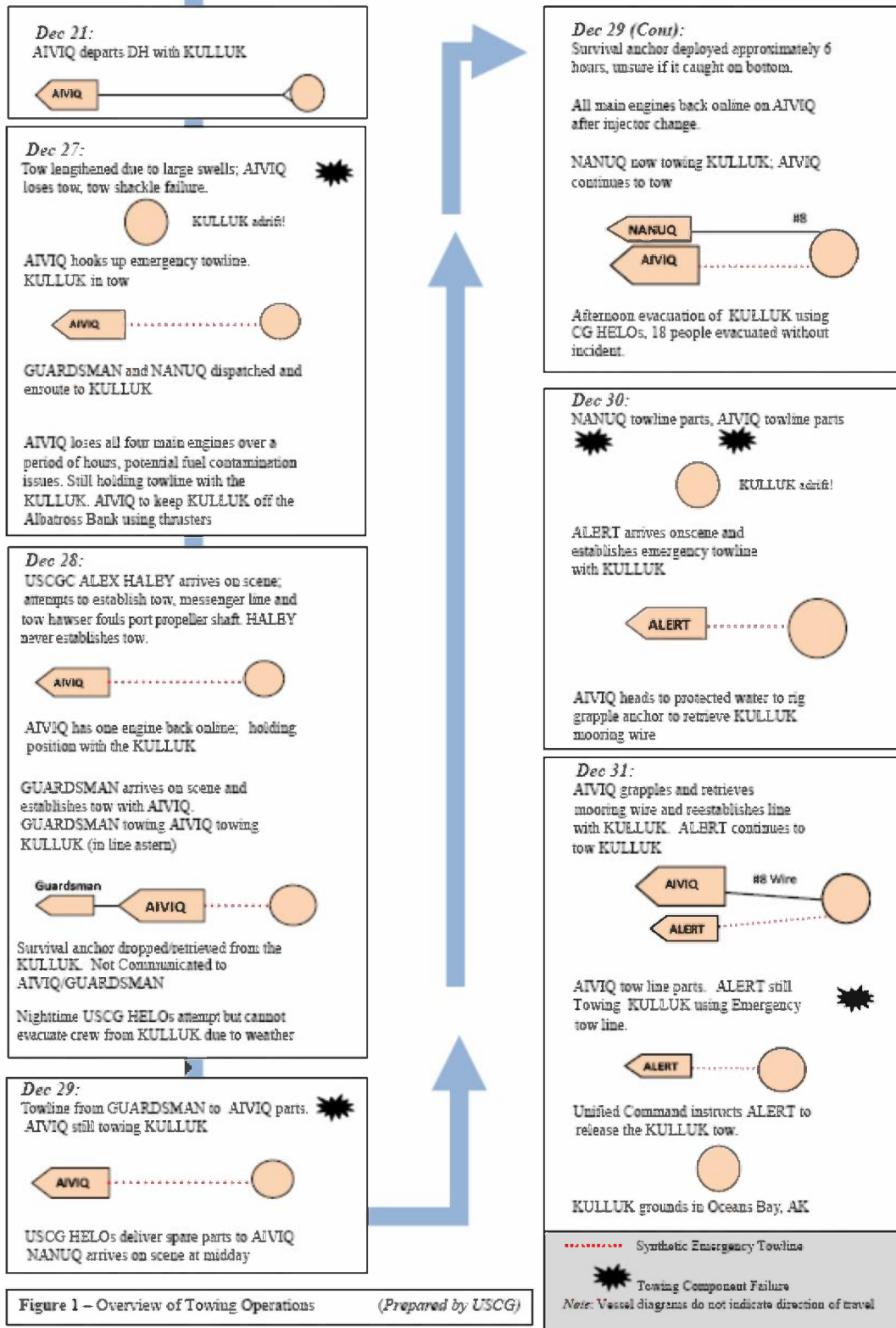
The USCG MISLE<sup>9</sup> Activity Number for this investigation is 4509765.

---

<sup>9</sup> Pursuant to 46 U.S.C. 3717, MISLE is an internal computer database maintained by the USCG. The acronym stands for Marine Information for Safety and Law Enforcement.



Significant Event Timeline Overview: Grounding of the KULLUK



**COMMONLY USED ACRONYMS**

The following table contains commonly used acronyms utilized throughout this report of investigation.

<b>Item</b>	<b>Acronym/Abbreviation</b>
Alaska	AK
Alaska Standard Time	AKST
Alternate Compliance Program	ACP
American Bureau of Shipping	ABS
Ballast Control Operator	BCO
Barge Engineer	BE
Breaking Load	BL
Bureau of Safety and Environmental Enforcement	BSEE
Captain of the Port	COTP
Chief Mate	CM
Closed Circuit Television	CCTV
Coast Guard	CG
Coast Guard Cutter	CGC
Conical Drilling Unit	CDU
Crowley Marine Services	CMS
Design Verification Test Procedure	DVTP
Dynamic Positioning	DP
Edison Chouest Offshore	ECO
Failure Mode and Effects Analysis	FMEA
Feet	FT
Hazard Identification	HAZID
Health , Safety and Environmental	HSE
Horsepower	HP
Ice Classed Anchor Handling Tug Supply	IAHTS
Incident Management Team	IMT
International Safety Management	ISM
Knot	KT
Main Diesel Engine	MDE
Marine Information for Safety and Law Enforcement	MISLE
Marine Warranty Surveyor	MWS
Metric Ton	MT
Mobile Offshore Drilling Unit	MODU
Morning Maintenance Report	MMR
National Oceanic and Atmospheric Administration	NOAA
National Weather Service	NWS
Nautical Miles	NM

Navigation and Vessel Inspection Circular	NVIC
Non-Destructive Testing	NDT
Officer in Charge Marine Inspection	OCMI
Offshore Installation Manager	OIM
Offshore Rig Movers International	ORMI
Offshore Systems Inc.	OSI
Proof Load	PL
Revolutions Per Minute	RPM
Safe Working Load	SWL
Safety Management System	SMS
Search and Rescue	SAR
Second Mate	2M
Ships Service Diesel Generators	SSDG
Third Mate	3M
Unified Command	UC
United States	US
United States Coast Guard	USCG
Washington	WA
Working Load Limit	WLL

**VESSEL DATA<sup>10</sup>**

**KULLUK**



*USCG Photo*

<b>Name:</b>	KULLUK
<b>Flag:</b>	Republic of the Marshall Islands
<b>Service:</b>	Mobile Offshore Drilling Unit (MODU)
<b>Official Number:</b>	802785
<b>Year Built:</b>	1979
<b>Builder:</b>	Mitsui
<b>Gross Tonnage, Inter. Tonnage Certificate:</b>	27, 968
<b>Length (ft):</b>	265.7
<b>Breadth:</b>	Vessel is conical in shape
<b>Draft:</b>	10.7 meters at time of sailing
<b>Propulsion:</b>	None
<b>Manning Under Tow:</b>	18
<b>Owner:</b>	Shell Offshore, Inc.
<b>Operator:</b>	Noble Drilling (US) LLC.

<sup>10</sup> Vessel specific information from a variety of sources including information submitted by vessel operators.

**AIVIQ**



*USCG Photo*

<b>Name:</b>	AIVIQ
<b>Flag:</b>	United States
<b>Service:</b>	Offshore Supply Vessel <sup>11</sup>
<b>Official Number:</b>	1237683
<b>Year Built:</b>	2012
<b>Builder:</b>	North American Shipbuilding LLC
<b>Gross Tonnage, Inter. Tonnage Certificate:</b>	12,892
<b>Length (ft):</b>	324.5
<b>Breadth (ft):</b>	80
<b>Draft (ft):</b>	28
<b>Propulsion:</b>	(4) Caterpillar Diesel Engines (1) 2,800 hp Azimuth Thruster Tunnel thrusters, (2) fore and (2) aft
<b>Total Shaft Horsepower:</b>	21,776
<b>Bollard Pull (Tons):</b>	208
<b>Crew:</b>	18 Crew, plus Mooring Crew & Medic
<b>Owner:</b>	Offshore Service Vessels, Inc.
<b>Operator:</b>	Galliano Marine Services, LLC.

<sup>11</sup> Also classed as an Ice Classed, Anchor Handling Tug Supply Vessel. (IAHTS)

**GUARDSMAN**



*Photo provided by Crowley Marine Services*

<b>Name:</b>	GUARDSMAN
<b>Flag:</b>	United States
<b>Service:</b>	Towing Vessel
<b>Official Number:</b>	572647
<b>Year Built:</b>	1976
<b>Builder:</b>	McDermott Shipyard
<b>Gross Registered Tons:</b>	199
<b>Length (ft):</b>	127.2
<b>Breadth (ft):</b>	36.5
<b>Draft (ft):</b>	16
<b>Propulsion:</b>	Twin engine diesel
<b>Total Shaft Horsepower:</b>	7,200
<b>Towing Capabilities:</b>	Markey TDSDW 36C double drum winch
<b>Bollard Pull (Tons):</b>	75
<b>Crew:</b>	7
<b>Owner:</b>	Crowley Marine Services
<b>Operator:</b>	Crowley Marine Services

**ALERT**



*Photo provided by Crowley Marine Services*

<b>Name:</b>	ALERT
<b>Flag:</b>	United States
<b>Service:</b>	Towing Vessel
<b>Official Number:</b>	1090636
<b>Year Built:</b>	2000
<b>Builder:</b>	Dakota Creek Industries
<b>Gross Tonnage, Inter. Tonnage Certificate:</b>	845
<b>Length (ft):</b>	125.9
<b>Breadth (ft):</b>	42
<b>Draft (ft):</b>	20
<b>Propulsion:</b>	Twin engine diesel through two azimuth thrusters (Z Drives)
<b>Total Shaft Horsepower:</b>	10,192
<b>Towing Capabilities:</b>	Markey TDS-40 Towing Winch
<b>Bollard Pull (Tons):</b>	150
<b>Crew:</b>	7
<b>Owner:</b>	Vessel Management Services, Inc.
<b>Operator:</b>	Vessel Management Services, Inc.

**NANUQ**



*USCG Photo*

<b>Name:</b>	NANUQ
<b>Flag:</b>	United States
<b>Service:</b>	Offshore Supply Vessel (OSV)
<b>Official Number:</b>	1195538
<b>Year Built:</b>	2007
<b>Builder:</b>	North American Fabricators LLC
<b>Gross Tonnage, Inter. Tonnage Certificate:</b>	3575
<b>Length (ft):</b>	279
<b>Breadth (ft):</b>	60
<b>Draft (ft):</b>	17
<b>Propulsion:</b>	Twin engine diesel with controllable pitch propellers and thrusters
<b>Total Shaft Horsepower:</b>	7,268
<b>Towing Capabilities:</b>	250 ton Anchor Winch
<b>Bollard Pull (Tons):</b>	90
<b>Crew:</b>	10
<b>Owner:</b>	Nautical Ventures, LLC.
<b>Operator:</b>	Nautical Ventures, LLC.



**U.S. COAST GUARD CUTTER ALEX HALEY**



*USCG Photo*

<b>Name:</b>	USCGC ALEX HALEY
<b>Flag:</b>	United States (Public Vessel)
<b>Service:</b>	Medium Endurance Cutter (WMEC)
<b>Official Number:</b>	N/A
<b>Year Built:</b>	1967
<b>Builder:</b>	Brooke Marine Lowestoft, United Kingdom
<b>Tonnage:</b>	3100 Long tons
<b>Length (ft):</b>	283
<b>Breadth (ft):</b>	50
<b>Draft (ft):</b>	17
<b>Propulsion:</b>	Diesel
<b>Total Shaft Horsepower:</b>	6800
<b>Towing Capabilities:</b>	Towing bit on fantail
<b>Crew:</b>	104
<b>Owner:</b>	United States Coast Guard

**VESSEL PERSONNEL INTERVIEWED<sup>12</sup>**

Last Name	First Name	Middle Name	Position	Vessel
██████	██	████	Master	AIVIQ
██████	██████	██████	Chief Mate	AIVIQ
████████	██	██████	2 <sup>nd</sup> Mate	AIVIQ
██████	██████	██	3 <sup>rd</sup> Mate	AIVIQ
██████	██████	██████	3 <sup>rd</sup> Mate	AIVIQ
████████	██	██	Chief Engineer	AIVIQ
██████	██████	██████	1 <sup>st</sup> Asst Engineer	AIVIQ
██	██████	(None)	Delmar, Deck Supervisor	AIVIQ
██	██████	██████	OIM	KULLUK
██████	██████	██████	Barge Engineer	KULLUK
██████	██	██████	Tow Master	KULLUK
██████	██	(None)	Shell Contract HSE Tech	KULLUK
████████	██	██	Master	GUARDSMAN
████████	██	██	Master	NANUQ
██████	██████	██████	Master	ALERT
██████	██████	██████	Commanding Officer	USCGC ALEX HALEY

**OTHER PERSONNEL INTERVIEWED DURING THE COURSE OF THE INVESTIGATION**

Last Name	First Name	Position	Company
██████	██████	Rig Move Supervisor (KULLUK)	Delmar
██████	██████	Shell Alaska Venture Ops Manager (Relief)	Shell Alaska
████████	██	Shell Alaska Venture Operations Manager	Shell Alaska
██████	██████	Shell Project Eng. KULLUK 2013 move	Shell
██████	██████	Shell Alaska Drilling Superintendent	Shell Alaska
██████	██████	Shell Alaska Venture Logistics	Shell Alaska
████████	██	Shell Alaska Marine Manager	Shell Alaska
██	██████	Tow Master (KULLUK previous voyages)	ORMI
████████	██	Manager, Regulatory Compliance, Naval Architect	Jensen Marine
██████	██████	Drilling Superintendent, KULLUK	NOBLE
██████	██████	Marine Operations Manager	MatthewsDaniel
██████	██████	Marine Warranty Surveyor (Previous moves)	MatthewsDaniel
██████	██	USCG Sector Anchorage COTP, OCMI	USCG
██████	██████	Terminal Manager, Shell Operations	OSI Captains Bay. Alaska
██████	██████	Operations Manager Edison Chouest	Edison Chouest Offshore

<sup>12</sup> Individuals assigned to involved vessels interviewed in the conduct of the investigation

**PARTIES IN INTEREST<sup>13</sup>**

<b>Parties in Interest</b>	<b>Role</b>	<b>Counsel</b>	<b>Representatives<sup>14</sup></b>
Shell Oil Company	Owner of KULLUK	In-House Counsel	Ms. ██████████
		Blank Rome LLP	Ms. ██████████
		Blank Rome LLP	Mr. ██████████
Noble Drilling, LLC	Operator of KULLUK	Keesal Young & Logan	Mr. ██████████
		Keesal Young & Logan	Mr. ██████████
		Keesal Young & Logan	Mr. ██████████
Edison Chouest Offshore	Owner of AIVIQ	LeGros Buchanan & Paul	Mr. ██████████
Noble Denton	Warranty Surveyors	Looper Reed & McGraw	Mr. ██████████
		Looper Reed & McGraw	Mr. ██████████ (of counsel)
Crowley Marine Services, LLC	Owners of ALERT and GUARDSMAN	Holland & Knight	Mr. ██████████
██████████	Noble Denton Warranty Surveyor	No counsel	
██████████	Master of the AIVIQ	Matthews & Zahare	Mr. ██████████ (of counsel)
██████████	Chief Engineer of the AIVIQ	Matthews & Zahare	Mr. ██████████ (of counsel)
██████████	1 <sup>st</sup> Mate of the AIVIQ	Matthews & Zahare	Mr. ██████████ (of counsel)
██████████	1 <sup>st</sup> Assistant Engineer of the AIVIQ	Matthews & Zahare	Mr. ██████████ (of counsel)
██████████	3 <sup>rd</sup> Mate of the AIVIQ	Law Office of Mark C. Manning PC	Mr. ██████████

<sup>13</sup> Party-in-Interest guidelines are set forth in Sections 6303 of Title 46 USC and Section 4.03-10 of Title 46 Code of Federal Regulations.

<sup>14</sup> Some Parties-in-Interest were represented by multiple attorneys through the course of the investigation. This table lists the attorneys who participated personally and substantially in preliminary discussions and interviews, the formal hearing, or both. Attorneys who participated solely to stand in for their colleagues for an occasional interview are not listed.

██████████	Offshore Installation Manager of the KULLUK	Doherty & Stuart	Mr. ██████████
██████████	Tow Master of the KULLUK	Feldman Orlansky & Sanders	Mr. ██████████
██████████	Master of the GUARDSMAN	Holland & Knight	Mr. ██████████
██████████	Master of the ALERT	Holland & Knight	Mr. ██████████

\* Mr. ██████████ changed his name in July 2013 to Mr. ██████████

**FINDINGS OF FACT:** *Tow background, equipment utilized, quality assurance, tow plan development, KULLUK towing operations and grounding*

All times referenced in this report are in Alaska Standard Time (AKST) unless otherwise noted.

**KULLUK Tow History**

1. The KULLUK had been previously towed on five occasions while owned by Shell. The table below indicates the towing operations for the KULLUK beginning in 2010. The December 2012 tow of the KULLUK from Dutch Harbor to the Seattle area would be the first tow of the KULLUK through the Gulf of Alaska during the winter months. Figure 2 below provides information regarding the KULLUK’s towing history.

Tow Plan Date	Route	Warranty Surveyor	Tow Master	Tow Vessels	Comments
August 2010	McKinley Bay, Canada to Dutch Harbor, AK	Noble Denton	Cenergy/ Shell	TOR VIKING II OCEAN TITAN (escort)	OCEAN TITAN was a trail/ steering tug out of McKinley Bay and an escort tug en route Dutch Harbor.
June 2011	Dutch Harbor to Seattle, WA (Vigor Shipyard)	Noble Denton	Crowley	NANUQ and OCEAN TITAN OCEAN RANGER (escort)	NANUQ was the lead towing vessel, assisted by OCEAN TITAN
June 2012	Seattle, WA to Dutch Harbor, AK	MatthewsDaniel	ORMI	AIVIQ	

August 2012	Dutch Harbor To Sivulliq, Beaufort Sea	MatthewsDaniel	ORMI	GUARDSMAN and WARRIOR towed KULLUK to Port Clarence  AIVIQ tows KULLUK from Port Clarence to Sivulliq with WARRIOR as an escort	AIVIQ sailed ahead to pre-lay anchors and, when done, met the tow at Port Clarence and took over the tow alone.
November 2012	Sivulliq, Beaufort Sea to Dutch Harbor	Noble Denton	ORMI	AIVIQ	
December 2012	Dutch Harbor to Port Angeles, WA	Noble Denton	ORMI	AIVIQ	Grounding of KULLUK

**Figure 2:** KULLUK Towing History (*Information in this table provided by Shell*)

**Decision to Move the KULLUK**

2. The KULLUK arrived in Dutch Harbor on November 22, having been towed south from the Beaufort Sea by the AIVIQ. It remained moored to OSI shipyard until getting underway in tow on the morning of December 21, 2012.

3. Several factors drove Shell’s decision to move the KULLUK from Dutch Harbor to Seattle in December 2012.

4. Before the close of the 2012 drilling season, Shell began to discuss the scope of work required to bring KULLUK back to the Beaufort Sea for the 2013 drilling season. A detailed list of repairs and modifications was developed for this shipyard period. The Shell Alaska Marine Manager, Alaska Logistics Manager and the Noble KULLUK Drilling Superintendent attested to the need for significant maintenance and repair before the vessel could be used for the 2013 season.

5. It is not clear from the record whether it was economically feasible to affect the repairs in Alaska. However, there were significant and costly logistical requirements if Shell decided to repair the vessel in Alaska. These requirements would have included the cost of bringing equipment to Alaska and the need to station various other vessels to handle KULLUK wastewater and other environmentally sensitive materials during the work. The record suggests that even if repairs in Alaska were technically feasible, it made more economic sense to move the KULLUK to Seattle for the repairs. The “operating committee” for Shell Alaska Venture, consisting of top managers and logistics personnel, decided to have Vigor shipyard in Seattle, Washington perform the offseason repairs on the KULLUK. Vigor shipyard was not available until February 2013. The final decision to move the KULLUK took place on December 7.<sup>15</sup>

6. Having decided to move the KULLUK, the team then considered several factors in deciding when to move the vessel. Detailed weather forecasts obtained by Shell predicted

<sup>15</sup> Testimony of Mr. ██████████ Shell Alaska Operations Manager, transcript page 1219

similar average wind and wave conditions for the time period of December 2012 through February 2013. The AIVIQ had also suffered an engine casualty on the southbound voyage that required repairs and ABS survey prior to the tow.

7. The Alaska tax laws also influenced the decision to make the tow. Shell believed the KULLUK qualified as taxable property and was subject to taxation under the state's laws applicable to personal property involved in the oil & gas industry. The tax would be assessed on January 1, 2013 if the vessel was still in Alaskan waters. Shell estimated that the tax liability would be in the millions of dollars if the vessel was located in Alaskan waters on January 1, 2013.<sup>16</sup>

8. Due to the unique conical shape of the KULLUK special docking requirements were required. Shell identified a suitable dockside berth at Port Everett, Washington, which could berth the KULLUK in January 2013 until the nearby Vigor Shipyard was available.

### **Development of the Towing Plan**

9. Tow Plans<sup>17</sup> were created and approved by Shell for each tow of the KULLUK. The purpose of these documents was to "support a consistent, safe method for the logistics and marine preparations and transit."<sup>18</sup> Each of the towing plans addressed topics such as the roles and interfaces, departure and ocean transit operations, communications, weather and forecasting, contingency plans, routing instructions and towing equipment. Shell was unable to produce any written policies or procedures that described the overall tow planning and approval process or the methodology for development of a tow plan such as the one utilized for the KULLUK tow.

10. Following the decision to move the KULLUK, Shell hosted a meeting in Anchorage to discuss the timetable for the KULLUK's departure from Dutch Harbor. In attendance were representatives from Shell, Noble Drilling, Edison Chouest, Offshore Rig Movers International, GL Noble Denton, Delmar and Impact Weather. Topics of discussion included KULLUK manning, warranty survey, pilots, towing vessel preparations, route, weather and security.<sup>19</sup>

11. A towing plan was developed by the Alaska Marine Manager and forwarded to reviewers for comment. The reviewers included numerous Shell employees (Alaska Operations Manager, Alaska Drilling Manager, Logistics Team Lead, Health Safety and Environmental Team Lead and Emergency Response Specialist, ORMI Tow Master, and Noble personnel (KULLUK Rig Manager and Operations Manager - Alaska) and the GL Noble Denton warranty surveyor. Final tow plan approval was received on December 21, 2012 which was the actual day of departure. Final approvers included the Alaska Venture Operations Manager, Alaska Well Delivery Manager, Alaska Logistics Team Lead, Alaska HSE Team Lead and the Alaska Marine Manager. All approvers were included as plan reviewers. The Alaska Venture Operations Manager was considered the final approval authority.

12. The Operations Manager, the individual normally designated as the final approver, was on holiday leave during the final tow planning process and the towing operation.

---

<sup>16</sup> Testimony of Mr. [REDACTED] marine formal hearing, transcript pages 1145 – 1153.

<sup>17</sup> Towing Plans are generated by responsible individuals for the companies involved (vessel owner/ operator/ towing companies) to document towing operations as dictated by internal company policies.

<sup>18</sup> From "KULLUK Location Move Captains Bay, Unalaska to Port Angeles Pilot Station", Shell KULLUK Towing Plan dated 21 December 2012.

<sup>19</sup> Shell meeting minutes dated 17 December, 2012.

13. Mr. [REDACTED] the individual who approved this tow plan had been employed by Shell for approximately six months. He had never reviewed a tow plan within Shell, had not participated in any of the planning meetings. In his relief capacity he had not received training in the tow planning or review process, and had not received any specific instructions, de-brief or guidance from his supervisor on this process.

14. There is no evidence that the towing plan was forwarded to any other federal or state entities for either review or approval. Additionally, the investigation could not locate any federal or state requirements to review or approve such plans.

15. While the Coast Guard did not receive or approve the towing plan document, the Coast Guard knew the KULLUK would get underway in late December. The KULLUK's general timeframe for departure, manning levels and general route were passed up the Sector Anchorage chain of command. Sector Anchorage expressed concerns over the manning of the KULLUK, as information received from personnel in Dutch Harbor was that there would be 90 personnel onboard during the tow. There appeared to be a miscommunication, as the KULLUK's manning for the voyage was to be eighteen personnel. There is no evidence to suggest that more than eighteen personnel were planned, and the proper manning levels were provided to the Coast Guard, who was satisfied with the manning level of the KULLUK.

**Manning of KULLUK**

16. The KULLUK was towed from Dutch Harbor to the Seattle, Washington area with a crew of eighteen persons. Conformance to the Flag State Manning requirements was stated as being the primary reason for sailing with personnel onboard the KULLUK.<sup>20</sup> Marshall Islands, the Flag State, required manning the tow in compliance with the Minimum Safe Manning Certificate (MSMC). This certificate listed the number of persons of various grades and positions.

The unit named in this document is considered to be safely manned, if when it proceeds to sea, it carries not less than the number and grades/capacities of personnel specified in the table(s) below.

Grade/capacity	Number of persons	
	On Location	Towed/Field Move <sup>†</sup>
Offshore Installation Manager	1	1
Barge Supervisor	1	1
Ballast Control Operators	2	2
Able Seaman (MODU)	2	2
Ordinary Seaman (MODU)	-	1
Survival Craft/Rescue Boat Crewmen**	8	8

**Figure 3:** Extracted portion of the Republic of the Marshall Islands Minimum Safe Manning Certificate for the MODU KULLUK, dated July 2007 (Extract from Marshall Island Manning Certificate)

17. The crew onboard the KULLUK during the December 2012 tow exceeded these requirements. Of note, two Safety Technicians and a Physician's Assistant were added to the crew to provide an added layer of safety for the personnel onboard.

<sup>20</sup> Interview with [REDACTED] Shell Logistics Manager

18. There were discussions before the development of the tow plan about towing the KULLUK without personnel aboard. The decision was made to tow with personnel aboard. No waiver for this Flag State manning requirement was requested.

Position	# Onboard	Employer
Rig Manager (OIM)	1	Noble
Barge Engineer	1	Noble
Ballast Control Operator	2	Noble
Electrician	1	Noble
Electrical Tech	1	Noble
Mechanic	1	Noble
Motorman	1	Noble
Rig Maintenance Supervisor	1	Noble
Welder	1	Noble
Physician Assistant	1	Beacon
Tow Master	1	ORMI
Compliance Engineer	1	MI Swanco
Cook	1	Doyon
Crane Operator	1	Noble
Assistant Rig Manager	1	Noble
Shell Safety (HSE)	2	SMS

**Figure 4:** KULLUK crew for the December 2012 voyage. (USCG Developed)

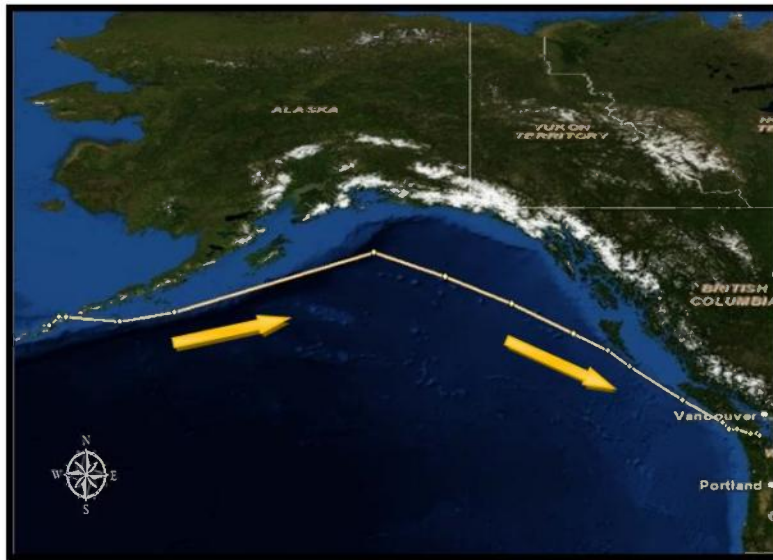
19. The Noble Drilling KULLUK riding crew was onboard primarily to monitor sea fastenings, watertight integrity and bilges during the voyage.<sup>21</sup> They could also assist in deploying the emergency towline and with the possible re-connection of tows should the need arise.

20. The KULLUK was manned during all tows during the 2012 season. A larger crew was aboard during the towing operations up to the drilling location during the tow from Dutch Harbor to the Beaufort Sea. In 2011, the KULLUK had been successfully towed unmanned during a tow from Dutch Harbor to Seattle for repair work with multiple towing vessels and an escort vessel.

<sup>21</sup> Instructions given to the KULLUK OIM by Mr. [REDACTED] Noble Drilling KULLUK Superintendent according to interview conducted 9 April 2013.



**Towing Route**



**Figure 5:** The December 2102 tow route for the voyage from Dutch Harbor to the Seattle area. *(USCG Developed)*

21. The route selected for the tow of the KULLUK by the AIVIQ for the December 2012 voyage has been described as a “coastal” or “northerly” route. The route, comprising nearly 1,780 nautical miles, was designed to keep the KULLUK no more than 200 miles from land to allow the tow to remain within Coast Guard Helicopter range should an emergency arise where a crewmember would require medical attention.<sup>22</sup> Use of a great circle or more direct route and shorter route for the KULLUK to the Seattle area was not chosen for this reason.

22. Both the AIVIQ Master and KULLUK Tow Master had the opportunity to review and approve the route taken. The AIVIQ Master made one minor correction to the eastern portion of the route (off Vancouver), moving the track of the vessels further offshore to provide more sea room as a contingency measure.

**Roles and Responsibilities**

23. The Towing Plan approved for the December 2012 tow of the KULLUK to the Seattle area contained responsibilities for key personnel.

24. The Tow Master’s responsibilities are contained in the excerpt below.<sup>23</sup> This position was held by Captain [REDACTED] of Offshore Rig Movers International.

“The Tow Master is responsible for controlling the movement of the KULLUK and the operation of all assisting vessels during the tow from unmooring at the OSI Captains Bay berth to completion of mooring at the Port of Everett. Specifically he will:

<sup>22</sup> Mr. [REDACTED] testimony, formal hearing, transcript page 938-940.

<sup>23</sup> Shell Tow Plan, Dated December 21, 2012.

- a. Carry out confirmation and inspection of assist vessels and KULLUK equipment ensuring all are working properly.
- b. Brief all vessel masters on the conduct and procedures of the KULLUK move operation.
- c. Interface between the assist vessels and the Drilling Foreman and KULLUK deck crew.<sup>24</sup>
- d. Advise the Drilling Foreman on the progress of the KULLUK move operation and of any changes to the KULLUK move plan which may be required in particular circumstances during the KULLUK move.
- e. Close liaison with the Marine Warranty Surveyor to ensure all intended actions are agreed and approved by him.”

25. The Offshore Installation Manager’s (OIM) responsibilities are contained in the excerpt below.<sup>25</sup> The position was held by Mr. [REDACTED] an employee of Noble Drilling.

“The Noble Offshore Installation Manager is the senior manager on the KULLUK and is ultimately responsible for the operations of the KULLUK. He will:

- f. Prepare the KULLUK for departure by assuring equipment is operational and/or secured as required or needed.
- g. Organize KULLUK operations to support unmooring and departure plan as specified by Tow Master.
- h. Interface between the KULLUK deck crew and the Tow Master.”

26. The Alaska Marine Manager’s responsibilities are contained in the excerpt below.<sup>26</sup> The position was held by Mr. [REDACTED] an employee of Shell. The Shell Alaska Marine Manager was responsible for the planning and execution for all of the KULLUK rig moves to include the rig moves in 2012.

“The Shell Alaska Marine Manager is responsible for the mobilization of the KULLUK from Unalaska to the Port of Everett and all aspects related to it as per the Shell KULLUK Mobilization Accountability Matrix (Appendix 3).”

Appendix 3 of the *Shell Tow Plan* specifies that the Marine Manager is controlling the operation while the KULLUK is under tow and in transit to the Everett area.

27. The Warranty Surveyor’s responsibilities are contained in the excerpt below.<sup>27</sup> Mr. [REDACTED] an employee of GL Noble Denton, was the warranty surveyor for the tow of the KULLUK from the Beaufort Sea to Dutch Harbor in November, and for the voyage under investigation.

“The Marine Warranty Surveyor (MWS) will evaluate aspects of the KULLUK and the (sic). This will include evaluating certificates, assessing the towing operation, and evaluating if the KULLUK is secured for sea. He is to ensure all reasonable steps have been taken and to ensure the safety of the tow from initial unmooring at the OSI terminal, Unalaska Island.”

---

<sup>24</sup> A Drilling Foreman was not part of the KULLUK crew, and the use of this term in the Towing Plan is considered an oversight. In lieu of the Drilling Foreman, it is assumed that these duties would fall to the Offshore Installation Manager (OIM).

<sup>25</sup> Shell Tow Plan, dated December 21, 2012.

<sup>26</sup> Id.

<sup>27</sup> Id.

28. There are no specific roles or responsibilities contained in the Towing Plan for the AIVIQ Master, Captain [REDACTED]. He understood that the towing plan directed him to follow the instructions of the Tow Master.<sup>28</sup> Figure 6 below addresses interfaces while the KULLUK is under tow.

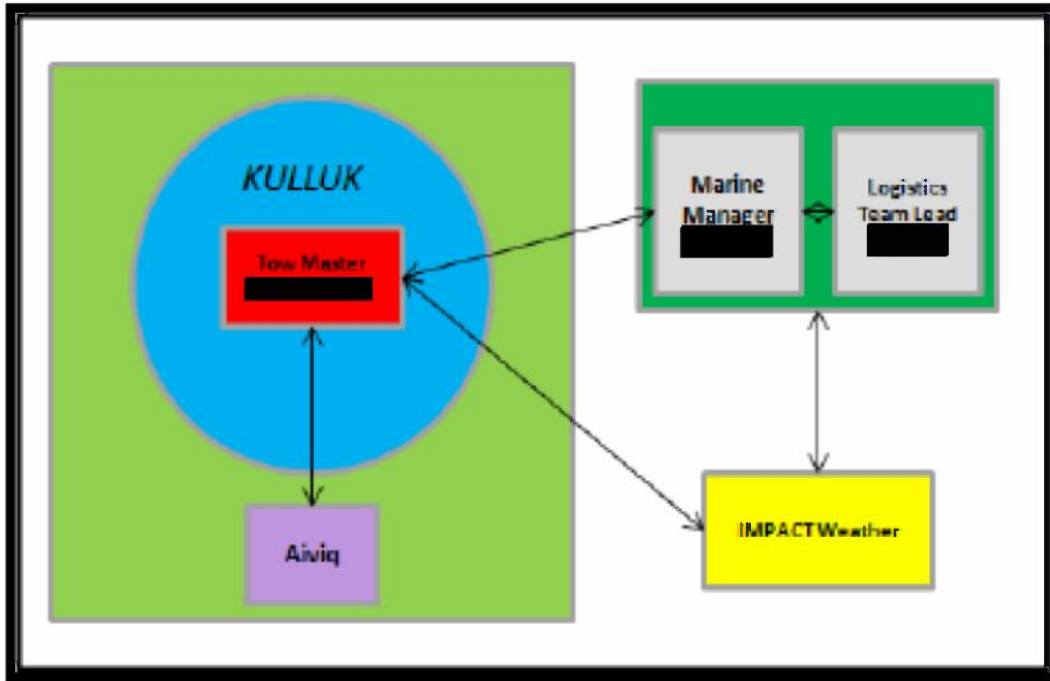


Figure 6: Interfaces as contained in the KULLUK towing plan dated December 21, 2012 (*Shell Tow Plan, December 21, 2012*)

### Tow Contingency Planning

29. The KULLUK tow planners addressed actions to take during certain contingencies. The following items are excerpts from the towing plan:<sup>29</sup>

#### 8.1 EMERGENCY TOW WIRE

The Kulluk will be rigged with a standard "insurance wire" emergency retrieval system, **Appendix 4**. If the emergency tow line is utilized, the tow unit will proceed, if necessary, to the available areas as determined in **Section 4**.

#### 8.2 CONTINGENCY RIG MOORING EQUIPMENT

The Kulluk will also be carrying 5 rig anchors (4 x 15 T Stevshark and 1 x 20 T Stevshark) with the associated pennant wires for mooring the Kulluk utilizing the mooring system if required.

#### 8.3 ORVILLE HOOK

A tow chain retrieval hook, referred to as an "Orville hook" is available to retrieve original tow gear if it has parted from the towing tug. The Orville hook is provided by the tow vessel.

<sup>28</sup> Testimony of Captain [REDACTED] formal hearing, transcript page 1666.

<sup>29</sup> Shell Tow Plan dated December 21, 2012.

**8.4 VESSEL**

If the M/V Aiviq shall, if possible, course away from situation as requ

30. While not addressed in the towing plan contingencies, the KULLUK was equipped with a 15 ton “LWT” type survival anchor and the associated diesel powered anchor windlass, chain (900 feet) and ground tackle used to secure the anchor in the stored or deployed position. The additional 5 anchors specified in the plan (see above) were stored on the rig and would require the use of the onboard crane(s) for deployment. As such, they would only be available for mooring in sheltered waters or in favorable weather conditions due to the limitations in using the cranes in a higher sea state.



**Figure 7:** Five anchors stored aboard the KULLUK before transit. These were for use when the towing operation reached the Seattle Area while the KULLUK awaited dock space availability. (USCG Photo)

31. Contingency assist vessels were not specifically planned for in advance for this towing operation, and as such are not contained in the towing plan.

32. Safe havens and anchorages were identified in the KULLUK towing plan, dated December 21, 2012. No specific guidance is provided with respect to when safe havens/ anchorages should be utilized. The State of Alaska Potential Places of Refuge (PPOR) were not listed in the Tow Plan, as only the Coast Pilot was referenced. The following item is an excerpt from the towing plan:

2. Snek
3. Prince
4. NW K.
5. Christi
6. Dixon
7. Hecat

**Hindsight Weather and Forecasting**

33. Shell commissioned a study that provided hindsight weather forecasting for the vessels as they moved along the potential KULLUK tow routes during a defined time period<sup>30</sup> and that study influenced part of the KULLUK tow planning in terms of routing for the towing operation.

<sup>30</sup> The study provides wind and wave encounter statistics along three possible routes from Dutch Harbor to Bellingham. The results compiled include 30 years of historical voyage data along the three routes examined.

In December of 2012, the study titled “*METOCEAN Design Criteria for Tows to/from Dutch Harbor, Alaska; and Bellingham, Washington*” was prepared for Shell in anticipation of the KULLUK tow to the Seattle area. The Shell Alaska Marine Manager understood that the exceedance levels in the study were the estimated time that you would expect to encounter the calculated sea and wind conditions along a specified route, which is a correct interpretation of the data provided. Tables from the study are listed in the figures on the following page and indicate the potential for extreme weather during the duration of the transit.

34. Shell contracted with Impact Weather to provide daily weather forecasts along the KULLUK route while the tow was at sea. These weather forecasts were specifically tailored for the towing operation. The weather forecast information was emailed to the KULLUK and AIVIQ on a daily basis and discussed during morning teleconferences. The vessels also had access to additional weather prediction sources through online sources while underway. In addition there were more detailed and frequent Impact Weather forecasts as the situation deteriorated.

Voyage maximum significant wave height in meters at various exceedance levels									
Month	----- Coastal Route ----			----- GC Route -----			----- RL Route -----		
	10% Exc	5% Exc	1% Exc	10% Exc	5% Exc	1% Exc	10% Exc	5% Exc	1% Exc
January	8.9	9.7	10.7	9.4	10.2	11.5	9.7	10.4	11.7
February	8.7	9.2	11.2	9.2	9.9	11.2	9.4	10.2	11.5
March	8.2	8.7	10.4	8.9	9.4	10.7	9.2	9.9	11.2
April	6.9	7.6	9.4	7.9	8.7	10.2	8.2	8.9	10.4
May	5.9	6.4	8.2	6.4	6.9	8.7	6.6	7.1	8.9
June	4.8	5.6	6.9	5.3	6.1	7.1	5.6	6.1	7.4
July	4.3	4.8	5.6	4.3	4.8	5.9	4.6	4.8	5.9
August	5.6	6.4	8.2	5.9	6.6	8.7	5.9	6.9	8.9
September	8.2	8.9	11.2	8.4	9.4	11.5	8.7	9.7	11.5
October	8.7	9.4	10.4	9.2	10.2	11.7	9.4	10.2	11.5
November	9.7	10.4	12.0	10.2	11.0	12.7	10.4	11.5	13.3
December	9.2	9.9	11.7	9.9	10.7	13.5	10.2	11.2	13.3

**Figure 8:** Excerpt from METOCEAN study showing wave height probabilities along three considered routes. From December 2012 study results. GC = Great Circle Route, RL = Rhumb Line Route (*Shell Met Ocean Study*)

Voyage maximum wind speed <sup>1</sup> in knots at various exceedance levels									
Month	---- Coastal Route ----			----- GC Route -----			----- RL Route -----		
	10% Exc	5% Exc	1% Exc	10% Exc	5% Exc	1% Exc	10% Exc	5% Exc	1% Exc
January	43.4	45.8	48.2	44.6	47.0	49.4	44.6	47.0	50.6
February	42.2	43.4	48.2	43.4	44.6	48.2	43.4	44.6	48.2
March	41.0	43.4	45.8	43.4	44.6	49.4	42.2	44.6	49.4
April	37.4	39.8	43.4	39.8	42.2	44.6	39.8	42.2	45.8
May	33.8	36.2	39.8	35.0	37.4	42.2	35.0	38.6	42.2
June	31.4	33.8	38.6	32.6	36.2	39.8	32.6	35.0	38.6
July	29.0	30.2	33.8	29.0	31.4	35.0	29.0	31.4	33.8
August	33.8	36.2	39.8	35.0	37.4	42.2	33.8	37.4	43.4
September	39.8	42.2	47.0	41.0	43.4	49.4	41.0	44.6	49.4
October	43.4	44.6	48.2	44.6	47.0	50.6	44.6	47.0	50.6
November	44.6	47.0	49.4	47.0	48.2	51.8	45.8	48.2	51.8
December	44.6	47.0	49.4	45.8	48.2	51.8	45.8	48.2	53.0

**Figure 9:** Excerpt from METOCEAN study showing wind speed probabilities along three considered routes. From December 2012 study results. GC = Great Circle Route, RL = Rhumb Line Route (*Shell Met Ocean Study*)

**Bollard Pull**

35. Bollard pull requirements for towing the KULLUK were determined to be 200 Tons, based upon a study conducted in 2010.<sup>31</sup> With a documented bollard pull of 208 Tons, the AIVIQ met this requirement to the satisfaction of the tow planners. There is no evidence to suggest that the bollard pull requirements were re-assessed prior to the December 2012 tow of the KULLUK based upon the Metocean study provided or anticipated weather conditions.

**Towing Configuration**

36. According to the Shell Alaska Marine Manager, the tow plan that was created for the December 2012 Dutch Harbor to Seattle tow of the KULLUK relied upon components of the plan that had previously been discussed by all principals in the early summer of 2012. This was prior to the mobilization of the KULLUK from the shipyard to the Alaskan drilling site for the 2012 season. Representatives from Shell, Noble Drilling, Edison Chouest, Delmar Systems, Offshore Rig Movers International and MatthewsDaniel participated in these early planning meetings. The decisions made regarding the towing equipment in those early 2012 summer meetings were to determine the towing and tow equipment plans for all phases of the KULLUK towing operations. These phases were considered as the voyages from Seattle to and from the Beaufort Sea for the 2012 drilling season. The Dutch Harbor to Seattle voyage in December 2012 was to be considered the last leg or phase of that operation. There is no evidence to suggest that the towing configuration was reassessed by Shell, Edison Chouest, the warranty surveyor or other parties involved in this investigation prior to the KULLUK’s departure from Dutch Harbor in December 2012.

<sup>31</sup> Testimony of Mr. [REDACTED] Shell Alaska Marine Manager, formal hearing, transcript page 917.

37. Shell contracted with MatthewsDaniel for warranty survey work for portions of the KULLUK towing operation.<sup>32</sup> The surveyor provided service for the voyage from Seattle to Dutch Harbor and the voyage from Dutch Harbor to the drilling location. The Marine Warranty Surveyor approved the towing configuration by ensuring it met criteria as set forth in *MatthewsDaniel Survey and Engineering Guidelines, Section V, Guidelines for MODU Field Moves and Ocean Tows dated January 2005*. This review of the towing components only addressed the voyages for which he had been hired to evaluate, which was the tow of the KULLUK from the Seattle area to the Beaufort Sea, by way of a stop in Dutch Harbor. See Figure 2.

38. Mr. [REDACTED] the GL Noble Denton warranty surveyor, used for the tows of the KULLUK from the Beaufort Sea to Dutch Harbor, and again from Dutch Harbor to Seattle (grounding of KULLUK) did not analyze or review the towing configuration to ensure it met GL Noble Denton's guidelines as published in *GL Noble Denton Technical Policy Board Guidelines for Marine Transportations revision 5* prior to approving the tows. Mr. [REDACTED] evaluated the towing components to ensure that they were in compliance with the Towing Plan as provided to him by Shell.

39. The primary towing configuration for the tow of the KULLUK by the AIVIQ included a single towing line that terminated at a towing plate. The configuration utilized shackles for the towing plate connections, a 100 foot pennant wire and 90 feet of surge chain. From the towing plate, there was a chain bridle made fast to fittings (Smit Brackets) on the deck of the KULLUK.

40. The SWL/WLL, PL and BL for primary tow configuration between the KULLUK and AIVIQ are listed in the following table. Figure 10 is based upon the actual configuration of equipment for the tow of the KULLUK in December 2012, detailed in testimony from vessel crewmembers and inspection of the equipment utilized. The equipment below would be connected to the AIVIQ's 3 ½ inch towline using 90 feet of 3 inch chain as surge gear.<sup>33</sup>

---

<sup>32</sup> These warranty surveys determine if the route, towing vessels, towing equipment, sea fastening, manning and other elements of the operation are adequate for the voyage. Marine warranty surveys follow guidelines that are established and align with accepted marine industry standards for such operations. MatthewsDaniel and GL Noble Denton had guidelines for the towage of MODUs.

<sup>33</sup> Surge gear is a generic term used to describe towing equipment installed to help absorb fluctuations in towline tension. Surge gear consists of chain to increase catenary (sagging) of a towline or lines that are designed to stretch to help absorb shock loading.

Equipment	SWL/ WLL Safe Working Load/Working Load Limit	PL Proof Load	BL Breaking Load
SMIT BRACKET		460 T	
4" MASTER LINK	186.5 T		
NO. 7 PEAR LINK		415 T	
76 MM BRIDLE CHAIN		507 T	
120 T SHACKLES	120 T	240 T	600 T <sup>34</sup>
TOW PLATE		460 T	
3 " PENNANT WIRE	85 T <sup>35</sup>		550 T <sup>36</sup>

Figure 10: KULLUK towing equipment (USCG analysis)

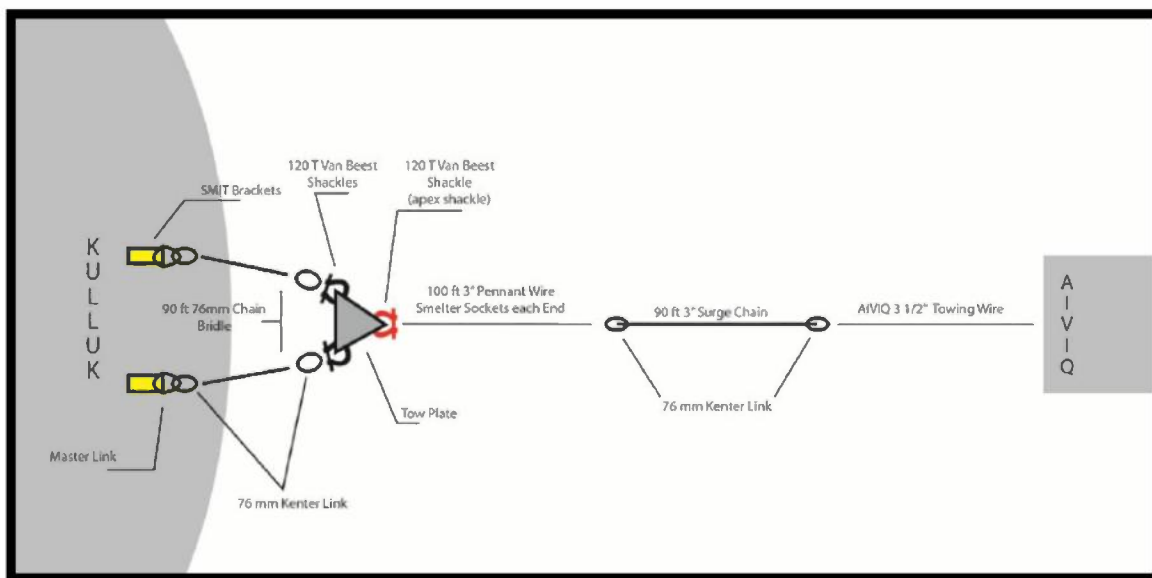


Figure 11: Diagram of towing configuration utilized in the KULLUK/ AIVIQ tows throughout 2012. (USCG developed)

41. The KULLUK was equipped with an emergency towline, designed for use should the primary towing configuration fail. Figure 12 is based upon the actual configuration of the emergency towline configuration for the tow of the KULLUK in December 2012 as detailed in testimony from vessel crewmembers and inspection of the equipment utilized. At the terminus end of the Saturn® 12 line there is an eye with a thimble<sup>37</sup> lashed into the eye. A shackle then connected the equipment to the assisting vessels towline. The emergency towline was configured so that it could be easily deployed by the KULLUK crew as necessary.

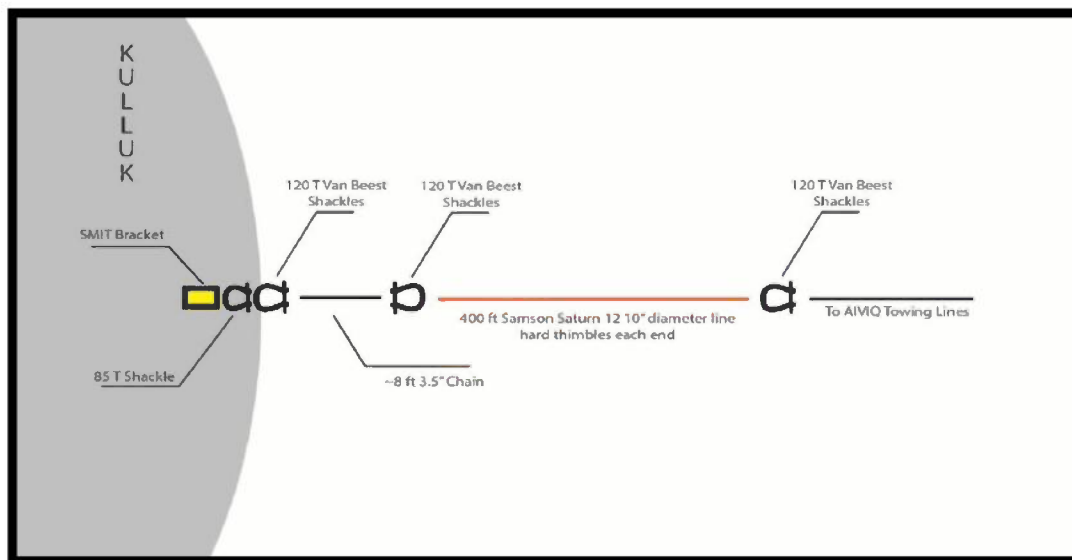
<sup>34</sup> Van Beest states that the Breaking Load is 5x the Working Load Limit (WLL) as stamped on the Shackle.

<sup>35</sup> Delta Rigging & Tools, Inc. Certificate of Compliance dated 6/15/12.

<sup>36</sup> Usha Martin Limited Inspection Certificate, dated December 14, 2009.

<sup>37</sup> A thimble is a piece of hardware that fits in the spliced eye of the towline to minimize wear and chafe.





**Figure 12:** Diagram of Emergency Towline as designed for use when under tow. (USCG developed)

42. Prior to the KULLUK and AIVIQ departing Seattle in July of 2012, there was a discussion about the main towing equipment and the 85 ton shackles that were originally specified to be used to connect the towing plate to the bridle and pennant wire. These same shackles were also specified to be used for the emergency towing equipment. The 85 ton shackles were replaced with 120 ton shackles at the request of the warranty surveyor and AIVIQ personnel. They had determined that the 85 tons shackles did not possess the breaking strength required by the MatthewsDaniel’s warranty survey guidelines.<sup>38</sup>

43. Following the recommendation to replace the shackles, six larger 120 ton shackles were located in an area on the Vigor Shipyard set aside for KULLUK equipment storage. These were identified as 120 ton Van Beest Green Pin Super Shackles. The shackles were removed from a storage bin located within this area and transferred onboard the KULLUK. According to the Delmar Rig Move Coordinator, Mr. [REDACTED] the three 85 ton shackles from the towing plate on the main towing arrangement and three from the emergency towing system were then replaced with these 120 ton shackles. Both the warranty surveyor and the Delmar Rig Move Coordinator stated that the shackles appeared to be in an “as-new” condition when removed from the yard and placed in service onboard the KULLUK. The other 120 ton shackles replaced the 85 ton shackles in the emergency tow line configuration. The one exception was an 85 Ton shackle which connected the KULLUK end of the line to the Smit bracket on the KULLUK’s stern. This change was not reflected in the Shell Tow Plan.

44. No paperwork, certificates or invoices were produced for these Van Beest 120 ton green Pin Super Shackles. Following the casualty, Van Beest offered a “Declaration” attesting to identification of the shackles as coming from their “YP” batch, identified by the forged markings located on the shackle and pin. In the declaration Van Beest attested that they test a representative sampling of each batch to the full proof load, which is twice the Working Load Limit (WLL). Only after a successful proof load test of a representative sampling of shackles from a batch are the shackles certified. Certificates may be issued for all shackles and the batch is released for sale. In this manner, all batches of Van Beest shackles are proof loaded

<sup>38</sup> Tows of the KULLUK from Seattle to the Beaufort Sea in 2012 were attended by and approved by a surveyor representing the warranty survey provider MatthewsDaniel.

prior to sale, and certificates would have been provided had they been requested by the purchaser.<sup>39</sup> The actual usage history of these shackles could not be positively ascertained.

45. The Shell towing plans called for the use of a galvanized, 40 foot long, 76 mm diameter pennant wire which would be connected to the AIVIQ side of the towing plate by way of a 85 Ton shackle (120 ton shackle was actually used). As a result of the May 2012 planning meetings the pennant wire was replaced with a new galvanized, 100 foot long, 3 inch wire in order to provide easier connections when making tow. The overall strength and construction<sup>40</sup> of this replacement wire was comparable to the one called for in the towing plan. This change was not reflected in the Shell Tow Plan.

46. All towing plans developed and approved for the KULLUK tows beginning in July of 2012 misidentified both the shackles and pennant wire to be utilized in the tows. The substitution of the 120 ton shackles for the 85 ton shackles, and the new pennant wire length were not documented. This would cause some individuals involved in the December 2012 towing operation, including the GL Noble Denton warranty surveyor, to misidentify the shackles being utilized during their inspection of the towing equipment and upcoming towing operation.

47. The KULLUK's emergency towline did not conform to the specifications in the tow plan. The towline as rigged had a significantly shorter chain and a series of shackles connecting the end of the chain to the Smit bracket. The 85 ton shackle which connected to the Smit bracket was a substantially weaker component than the remainder of the emergency towline configuration. The 85 ton shackle did not fail during this casualty. The reason this shackle was not replaced with a 120 ton shackle could not be determined.

### Warranty Surveys

48. Warranty surveys are conducted, generally as a requirement of the insurance underwriters, to ensure the safety of the rig and personnel for the specific voyage. As a third party assurance measure, Shell provided for marine warranty surveyors to examine and approve each tow of the KULLUK in 2012. For the tow of the KULLUK from Seattle and eventually to the Beaufort Sea warranty survey services were provided by MatthewsDaniel. GL Noble Denton was hired by Shell for the tow of the KULLUK from the Beaufort Sea to Dutch Harbor in November of 2012 and again for the towing operation under investigation.

49. In September of 2012, the Shell Alaska Logistics Manager was advised by Shell Finance in Anchorage that a warranty survey was not required for towages of the KULLUK as a part of the insurance underwriting for the voyage. Although not required, the Shell Marine Manager and Logistics Manager decided it was important to earn third party assurance and a decision was made to utilize warranty surveys for the KULLUK tows from the Beaufort Sea to Dutch Harbor and again to the Seattle area.<sup>41</sup>

50. Shell contacted MatthewsDaniel prior to the KULLUK's departure from the Beaufort Sea to request warranty survey services. In preliminary correspondence with Shell, MatthewsDaniel stated in writing that they "would not approve a tow of the KULLUK from Dutch Harbor to

---

<sup>39</sup> Van Beest Declaration, dated May 12, 2013.

<sup>40</sup> Both wire were of similar construction, being of similar diameter (76mm = 2.99 inches), galvanized, and of Independent Wire Rope Core (IWRC) construction. Assumed safe working load of the original 40 foot wire is approximately 77 ½ tons assuming that safe working load is half the proof load of 155 contained in the towing plan.

<sup>41</sup> Ms. ██████████ Shell Logistics Manager, interview conducted 18 April 2013.

Seattle during the month of November as weather data shows that seas can reach as much as 10 meters in the Gulf of Alaska.”<sup>42</sup>

51. The Shell Marine Manager stated that MatthewsDaniel was not hired for warranty survey work for the southern voyages of the KULLUK because MatthewsDaniel did not have personnel that could attend the vessel while in the Beaufort Sea. GL Noble Denton was contacted and had personnel who could attend the vessel.<sup>43</sup>

52. On December 15, the Marine Warranty Surveyor (MWS), Mr. [REDACTED] was assigned to conduct the KULLUK voyage survey. Mr. [REDACTED] had conducted survey work for Shell on two other occasions. These occasions were the voyages of the KULLUK from Dutch Harbor to Seattle in 2011 and the voyage from the Beaufort Sea to Dutch Harbor at the beginning of November 2012. The GL Noble Denton marine warranty surveyor attended the KULLUK in both the Beaufort Sea and in Dutch Harbor in late 2012 and issued tow approval certificates.<sup>44</sup> The warranty survey conducted in December 2012 consisted of a suitability report for the AIVIQ, inspection on towing equipment, and a survey of the KULLUK to ensure the vessel was ready for sea. He did not conduct an independent assessment concerning the overall adequacy of the towing equipment. He accepted the configuration contained in the towing plan as suitable for the voyage. He stated that conducting this type of analysis was not in his scope of work as a warranty surveyor and was never asked to assess the towing equipment configuration and components.<sup>45</sup>

### **Pre-Departure Condition of the Single Towing Vessel AIVIQ**

53. The AIVIQ had been involved with all previous tows of the KULLUK since the summer of 2012. The AIVIQ was a vessel which was delivered in late spring of the same year. As the AIVIQ was prepared for this voyage there were two areas that affected the upcoming towing plans. One concern was the vessels design issues, which was identified as water ingress into the winch room and safe deck areas affecting the vent on the fuel system and electrical fittings in the space. The Master of the AIVIQ sent ECO management an email entitled “Storm Damage Lessons Learned” and added a statement from a former crewmember detailing an account of a storm while AIVIQ was towing the KULLUK. In that account the crewmember detailed the AIVIQ taking on a sustained list in the storm due to sea water ingress. As temporary measure to limit water ingress internal openings in the winch room were closed or covered, the hinged freeing port covers were removed and temporary covers were placed over the lower winch room openings to the main deck prior to the voyage commencing.

54. The other issue was a host of mechanical problems that had occurred on previous voyages. There were issues with the engine room automation, resulting in the overheating of the main diesel engine #4 and complete failure of that engine on the voyage south with the AIVIQ towing the KULLUK to Dutch Harbor. Some of these issues were required to be reported to the classification society, ABS and the U.S. Coast Guard. The major issues<sup>46</sup> are mentioned here and remained unresolved as the AIVIQ was readied for sea. As the AIVIQ was prepared for sea the following items were noted in vessel generated reports.

---

<sup>42</sup> E-mail from Mr. [REDACTED] MatthewsDaniel, to Mr. [REDACTED] dated October 9, 2012.

<sup>43</sup> Testimony of Mr. [REDACTED] before the marine investigating board, transcript page 1048.

<sup>44</sup> Tow approval certificates are issues to vessel owners/ operators and grant approval to tow.

<sup>45</sup> Testimony of Mr. [REDACTED] GL Noble Denton warranty surveyor, formal hearing, 25 May 2013.

<sup>46</sup> Source: (MMR) AIVIQ Morning Maintenance Reports to ECO, (CE Email) December 25<sup>th</sup> email from Chief Engineer to ECO with list of shipyard availability work items.

- a. *“Rudders are getting locked at 20 degrees port and starboard in manual or in DP mode” (MMR throughout the voyage, ECO Tracking No. B247081912-21)*
- b. Vessel sustained considerable equipment damage due to shipping water over the stern in rough weather. Safe decks were flooded due to lack of WT integrity cause damage and loss of stability. *(Paraphrase ECR MMR Tracking No. B-247121612-55) (Note: The vessel had temporary covers fitted over the lower winch opening and ship’s crew removed the swinging freeing port covers on the side of the vessel. However damaged equipment in the safe deck areas was not addressed prior to departure)*
- c. *“#1 stern tunnel thruster .... currently the thruster is not useable” (Item 35 CE Email)*
- d. The rotating bow thruster could only be operated in constant speed *(Item 3 CE Email)*
- e. Starboard controllable pitch propeller was listed as 20 degrees off in ahead and astern *(Paraphrase ECO MMR Tracking No. B-2470561232-5)*
- f. Crack in #2 center cargo fuel oil tank *(Paraphrase Item 35 CE Email, ECO MMR Tracking No. B-24706312-15)*
- g. Fast response craft had cracks in heat exchanger and associated parts and was listed as “out of commission” *(Paraphrase Item 21 CE Email and ECO MMR Tracking No. B247121612-54) (Note: During testimony the Master of the AIVIQ stated that temporary repairs were made and that the vessel was operational. ABS or the USCG was not notified of the deficiency or the temporary repairs. This vessels is lifesaving equipment)*
- h. Starboard shaft generator not working as designed reducing electrical output *(Paraphrase Item 4 CE Email and MMR throughout voyage, ECO MMR Tracking No. B-247102812-28)*
- i. *“Tank vents in safe deck areas need removal and inspection for damage caused by storm, some vent screens and vent check balls will be required (Item 28 CE Email)*
- j. *“Fuel KRAL meters ....suffered numerous failures” (Item 29 CE Email)*
- k. *“Daughter craft needs to be attended to by a tech rep and the wiring and electronics inspected or replaced due to saltwater damage incurred from storm damage.” (Item 22 CE Email)*
- l. Safe deck and main deck fire mains susceptible to freezing as occurred 2012, need heat tracing *(Paraphrase Item 35 CE Email)*

### **Dutch Harbor Preparations for Tow (19 – 21 December 2012)**

55. On December 19, the GL Noble Denton warranty surveyor arrived in Dutch Harbor to conduct a vessel suitability inspection of the AIVIQ. He had previously sent a questionnaire to the vessel in advance of his arrival, using the feedback that was provided to determine the readiness of the vessel for the upcoming operation. He found the vessel suitable for the tow. According to his interviews with the crew, the results of the survey, and a survey of the vessel, he noted no deficiencies with the vessel.<sup>47</sup>

56. The warranty surveyor also conducted an inspection of the KULLUK which included examination of the voyage related paperwork, sea fastenings and towing equipment. He examined certificates for the towing equipment, including that for the main bridle and the pennant wire shackles. He failed to notice that the shackles were different from what was documented in the towing plan, and believing the shackles to be 85 tons, examined certificates that were onboard KULLUK for the 85 ton shackles that had been replaced in Seattle prior to the 2012 season. The shackles he examined were actually 120 ton shackles.

57. On the morning of December 21, a meeting was held involving the Tow Master, AIVIQ Master, warranty surveyor, local pilots and the Shell Alaska Marine Manager to determine if the weather conditions were suitable to begin the voyage. The Impact Weather forecast provided for

<sup>47</sup> Testimony of Mr. ██████████ GL Noble Denton, during the formal hearing, transcript page 1272.

the towing route, and available to the participants, is described below. All participants agreed that the weather was suitable to proceed. This meeting focused on the departure from Captains Bay and did not look out into the Gulf of Alaska for the weather's impact on the whole tow route. A satisfactory five day forecast was received and prompted the decision to go ahead with the tow. The Shell Alaska Marine Manager received final approval for the tow from the Acting Shell Alaska Operations Manager following the meeting.<sup>48</sup>

***Dutch Harbor I Kulluk<sup>49</sup>***

***This forecast assumes a departure from Captain's Bay Friday morning\*\*\****

*Southeasterly winds are now forecast to remain just at moderate to fresh levels through midday Friday as the vessel departs Captain's Bay. Winds will shift to northwest and increase up to strong levels around mid-afternoon Friday with seas increasing also just to the east-northeast of Unalaska as a front pushes eastward across the region. The strongest winds and highest seas can be expected Friday evening/night as the vessel transits Unimak Pass. Strong northwesterly winds are now forecast to continue along the route through the weekend, however, sea states will be limited to due to nearby land to the north of the route. Wind and sea conditions will gradually decrease by Tuesday and Wednesday as the vessel nears the Shelikof Strait. Expect occasional rain showers through the day Friday, then mixing with/changing to snow Friday evening before tapering on Saturday.*

***Friday, 21 December to Saturday, 22 December (54.2N 164.4W at 22/0300):*** Cloudy with scattered rain/snow showers, mainly through Saturday morning. Winds: NW-NNW 22-27G37

*Combined Waves: 5-7 ocnl9 ft.*

***Saturday, 22 December to Sunday, 23 December (54.8N 162.0W at 23/0300):***

*Mostly cloudy with isolated snow showers.*

*Wind NW-NNW 20-25 G35 kts. Combined waves 5-7 ocnl9 ft.*

***Sunday (54.8N 162.0W at 23/0300):*** Wind NNW-N 20-25 G35 kts. Combined waves 5-7 ocnl 9ft. ***Monday (55.4N***

***159.7W at 24/0300):*** Wind dec WNW-NW 12-20 G25 kts. Combined waves dec 3-5 ocnl 6ft.

***Tuesday (56.3N 157.6W at 25/0300):*** Wind W-NW 7-15 G20 kts. Combined waves 1-4 ocnl 5 ft.

***Wednesday (57.3N 155.3W at 26/0300):*** Wind shift NE-E 12-20 G25 kts. Combined waves 3-5 ocnl6 ft.

58. On the morning of December 21, a flatbed truck arrived at the OSI Terminal Yard in nearby Captains Bay. Onboard this flatbed trailer was the 100 foot towing pennant wire, shackle and towing plate to be used for the KULLUK tow by the AIVIQ. The pennant wire was connected to the towing plate by way of the 120 ton shackle which was secured with a locking nut and cotter pin. All three pieces of equipment had been maintained onboard the AIVIQ since the KULLUK arrived in Dutch Harbor on November 22, 2012. This equipment was coiled for shipment on the flatbed trailer. A yard crane from the OSI Terminal removed the palletized towing equipment from the flatbed trailer and placed it in close proximity to the preparation area on the gravel yard near the KULLUK.

59. As the KULLUK began to make preparations to depart, the two KULLUK towing bridle legs were released from their moorings ashore<sup>50</sup> and the shoreward end of each chain was laid out on the gravel in the yard. The shipboard ends of each bridle leg remained secured in their Smit brackets aboard the KULLUK.

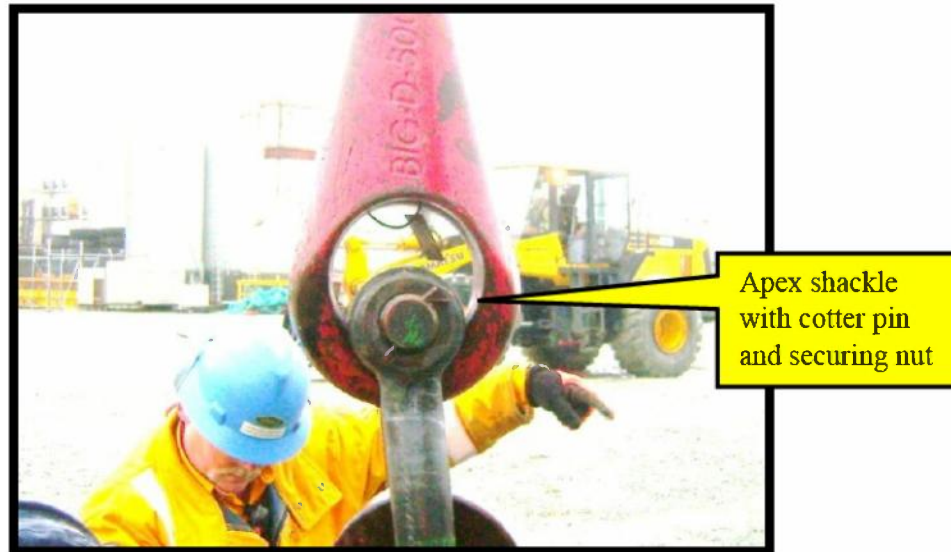
60. The shackle connecting the towing plate to the pennant wire had not been disconnected since the previous tow of the KULLUK. According to the Delmar Rig Move Coordinator and the warranty surveyor, who witnessed the connection of the bridle chains to the towing plate, the cotter pin for this shackle was properly installed. According to the warranty surveyor, no significant wear, broken parts or distortions were noted to this shackle during the visual

<sup>48</sup> Testimony of Mr. ██████████ Shell Alaska Marine Manager, formal hearing, transcript page 1029.

<sup>49</sup> Daily KULLUK Tow/ Marine Operations Report, dated 21 December 2012.

<sup>50</sup> The KULLUK bridle legs formed part of the mooring arrangement for the vessel in Captain's Bay.

inspection. Additionally, the cotter pin was not removed or replaced.<sup>51</sup> It is assumed that this is the same cotter pin that was installed for the July 2012 tow at the beginning of the season. Figure 13 shows a photo provided by the warranty surveyor that shows the “apex” shackle and cotter pin.



**Figure 13:** OSI Terminal workers hoist the tow plate and pennant wire. The photo shows the 120 ton shackle (original photo brightness adjusted) with the cotter key. The shackle (described as apex shackle) connects the tow plate to the 100' tow pennant socket. (Photo courtesy of GL Noble Denton, Mr. █████)



**Figure 14:** Preparing to Connect the Towing Plate to the Bridle Legs (Photo courtesy of GL Noble Denton, Mr. █████)

61. The evidence indicates that the 120 ton apex shackle connecting the towing pennant to the towing plate had been in the same location for all previous KULLUK tows. The evidence also indicates that the rotation of shackles to even the wear and usage of these critical components was not part of the towing plan or equipment maintenance procedures.

<sup>51</sup> Testimony of Mr. █████ █████ GL Noble Denton, formal hearing, transcript page 1280.

62. Using an OSI yard crane, the towing plate was maneuvered using the connected pennant wire and shackle as to allow shore side personnel to connect the two bridle chains to the towing plate, by way of shackles. Locking nuts were placed on the shackles and they were properly secured with cotter keys. See Figure 14. Once the shackles were connected, the towing configuration was raised by KULLUK's cranes into a standby position for connection to the AIVIQ once away from the dock.

63. The warranty surveyor provided nineteen photos of the KULLUK towing equipment including the main towing equipment, Smit brackets and bridle chains and the actual photos of the KULLUK under tow in Captains Bay. He did not provide any photographs of the emergency towing arrangement or equipment.

### **Dutch Harbor & Under Tow (21 – 27 December)**

64. At approximately 1325 on December 21, the KULLUK was maneuvered away from the OSI dock into Captains Bay, Unalaska, by the towing vessels GUARDSMAN, DUNLOP and FALCON. These vessels maneuvered the KULLUK into a position for tow hookup with the AIVIQ who was maneuvering in close proximity off the dock.

65. At approximately 1400 the KULLUK transferred the main towing pennant to the deck of the AIVIQ using the KULLUK pedestal crane. Once on deck, the towing pennant was connected to a 3 inch diameter, 90 ft. long length of surge chain using a 3 ½ inch connecting link. This towing chain was then connected to the main towing line of the AIVIQ. By 1515 hrs the GUARDSMAN, DUNLOP and FALCON had released their towing lines from the KULLUK. The AIVIQ was now towing the KULLUK without assistance en route to the Gulf of Alaska.

66. At approximately 1500, December 22 the AIVIQ with KULLUK in tow cleared Unimak Pass and reached the open sea.

67. On December 22, the AIVIQ Master sent the following in an email to the Tow Master aboard the KULLUK.

█  
*To be blunt I believe that this length of tow, at this time of year, in this location, with our current routing guarantees an ass kicking. In my opinion we should get to the other side just as soon as possible. If the event that our weather resources can route us "around" an area that will jeopardize any personnel or equipment on either the Kulluk or the Aiviq we should strongly consider the recommendation and deal with any logistics issues as they develop.*

█  
*I.A.H.T.S. "AIVIQ"*

68. On December 22, the KULLUK Tow Master and AIVIQ Master discussed adjusting the towing route, to clear Unimak Pass then transit to Everett via a great circle route.<sup>52</sup> Aboard the KULLUK, concerns superseded the selection of this route due to the importance of remaining on

---

<sup>52</sup> A great circle track is the shortest distance between two points on the surface of a sphere, which would have taken the KULLUK on a route further offshore and reduced the overall transit time of the tow.

a northern route to stay within SAR coverage range of Coast Guard helicopters.<sup>53</sup> While the weather was still moderate, forecasts indicated heavier seas and wind beginning on December 25.

69. The 0400 December 22 National Weather Service forecast for the nearby waters was as follows:

PKZ132-230300-  
SHUYAK ISLAND TO SITKINAK  
400 AM AKST **SAT DEC 22** 2012

.TODAY...N WIND 20 KT. SEAS 5 FT.  
.TONIGHT...N WIND 15 KT. SEAS 6 FT.  
.SUN...SE WIND 15 KT. SEAS 6 FT.  
.SUN NIGHT...E WIND 35 KT. SEAS 11 FT.  
.MON...SW WIND 25 KT. SEAS 10 FT.  
.TUE...SW WIND 30 KT. SEAS 14 FT.  
.WED...SE WIND 35 KT. SEAS 17 FT.

70. The Shell Tow Plan for the voyage makes the following provision about changes in route.

**"4.1 ROUTE**

*The tow route as detailed below allows for a navigationally safe and efficient passage. The route may be adjusted allowing for the prevailing and forecasted weather at the discretion of the Tow Master and Aiviq Master.*<sup>54</sup>

71. The AIVIQ Master maintained Vessel Specific Standing Orders in addition to the orders for the Officer in Charge of the Navigational Watch which were pre-printed. These orders were generated at 1800 each day. On December 22 the orders called for the vessel to remain at 70 % load (on the engines) until we (*Referring to the AIVIQ with KULLUK in tow*) get out of the current then slowly increase to 80% load. On December 23 until December 27 the vessel's officers were instructed to remain at 80 % load as long as temps (temps refer to the limits imposed by the temperature of the engine turbocharger under load) allow.

72. At 0830 hrs on December 25, AIVIQ noted a minor leak (crack) in the oil pan for their #2 MDE. Because of this leak, the engine would periodically be taken off-line to allow engineers to check the oil levels to monitor oil consumption on that engine. The AIVIQ Master didn't believe it would affect the completion of the tow, but apprised Edison Chouest, the Tow Master and Shell of the issue.

73. On December 25, the AIVIQ Captain and the Tow Master began discussing a course change to the east, a direct course from their current position to intersect with the eastern track of the intended tow route near Vancouver, Canada. The intention would be for the tow to take a more southerly route to keep on the southern side of approaching low pressure systems. Concerns were forwarded to the Shell Alaska Marine Manager, Mr. [REDACTED]

74. The National Weather Service forecast for the morning of December 25 for nearby waters was:

PKZ132-260300-  
SHUYAK ISLAND TO SITKINAK  
400 AM AKST **TUE DEC 25** 2012

...GALE WARNING TONIGHT AND WEDNESDAY...

<sup>53</sup> E-mail from [REDACTED] Tow Master to [REDACTED] AIVIQ Master, dated 22 December 2012.

<sup>54</sup> Shell Tow Plan, December 21, 2012.



.TODAY...W WIND 15 KT BECOMING S IN THE AFTERNOON. SEAS 11 FT.  
 .TONIGHT...SE WIND 20 KT BECOMING E 35 KT AFTER MIDNIGHT. SEAS  
 12 FT. RAIN.  
 .WED...SE WIND 40 KT. SEAS 15 FT. RAIN AND SNOW.  
 .WED NIGHT...SE WIND 30 KT. SEAS 16 FT.  
 .THU...S WIND 30 KT. SEAS BUILDING TO 21 FT.  
 .FRI THROUGH SAT...SE WIND 30 KT. SEAS SUBSIDING TO 14 FT.

75. The National Weather Service forecast for the morning of December 26 for nearby waters was:

PKZ132-270300-  
 SHUYAK ISLAND TO SITKINAK  
 400 AM AKST **WED DEC 26** 2012

...GALE WARNING THROUGH THURSDAY...

.TODAY...E WIND 45 KT BECOMING SE 30 KT IN THE AFTERNOON. N OF  
 DANGEROUS CAPE...E WIND 25 KT INCREASING TO 45 KT BY MIDDAY. SEAS 16  
 FT. RAIN AND SNOW.  
 .TONIGHT...SE WIND 35 KT. SEAS 19 FT. RAIN AND SNOW.  
 .THU...SE WIND 35 KT DIMINISHING TO 25 KT BY AFTERNOON. SEAS 22 FT.  
 RAIN AND SNOW.  
 .THU NIGHT...S WIND 20 KT. SEAS 19 FT.  
 .FRI...SE WIND 35 KT. SEAS 18 FT.  
 .SAT...SE WIND 30 KT. SEAS 14 FT.  
 .SUN...E WIND 30 KT. SEAS 22 FT.

76. Up to this point of the transit, the weather had been moderate. Beginning late on December 25, a low pressure system was moving in from the southwest. Because of this, the observed seas increased through the morning of December 27.<sup>55</sup>

Time	Wind (Knots)	Seas (Feet)	Pitch Degrees	Roll Degrees
0000 25 Dec	10 – 15 S	4 – 6	2	1
0600 25 Dec	20 – 25 ESE	5 – 7	1 – 2	1
1200 25 Dec	20 – 25 ESE	5 – 7	1 – 2	1
1800 25 Dec	15 – 20 ESE	6 – 8	1 – 2	1
0000 26 Dec	35 – 40 ESE	10 – 12	5	5
0600 26 Dec	45 ESE	15	7	7
1200 26 Dec	30 ESE	9 – 10	6	5
1800 26 Dec	25 – 30 ESE	12 – 15	6	5
0000 27 Dec	25 – 30 ESE	15 – 18	6 – 8 <sup>56</sup>	6 – 8
0600 27 Dec	20 – 25 ESE	20	8 – 10	8 – 10

**Figure 15:** KULLUK weather & rig motion data (Pitch/Roll). (USCG developed and extracted from KULLUK logs)

<sup>55</sup> Weather information as observed by KULLUK crew, according to KULLUK logbook.

<sup>56</sup> From Section 3.1.20 of the Shell Kulluk Operations Manual:

While towing during rough weather, if the Kulluk's roll or pitch regularly exceeds 6° from vertical the following procedures should be followed:

- Reduce speed to a minimum, or stop, to reduce the period of encounter with waves.

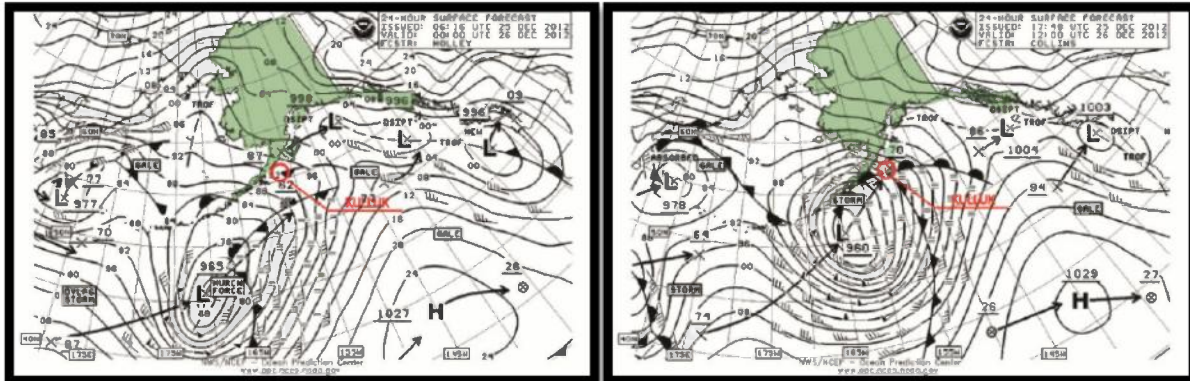


Figure 16: 24-hour NOAA surface forecasts for December 26. All times UTC. (NOAA surface forecasts published on the internet and the Alaska portion of the map highlighted for clarity)

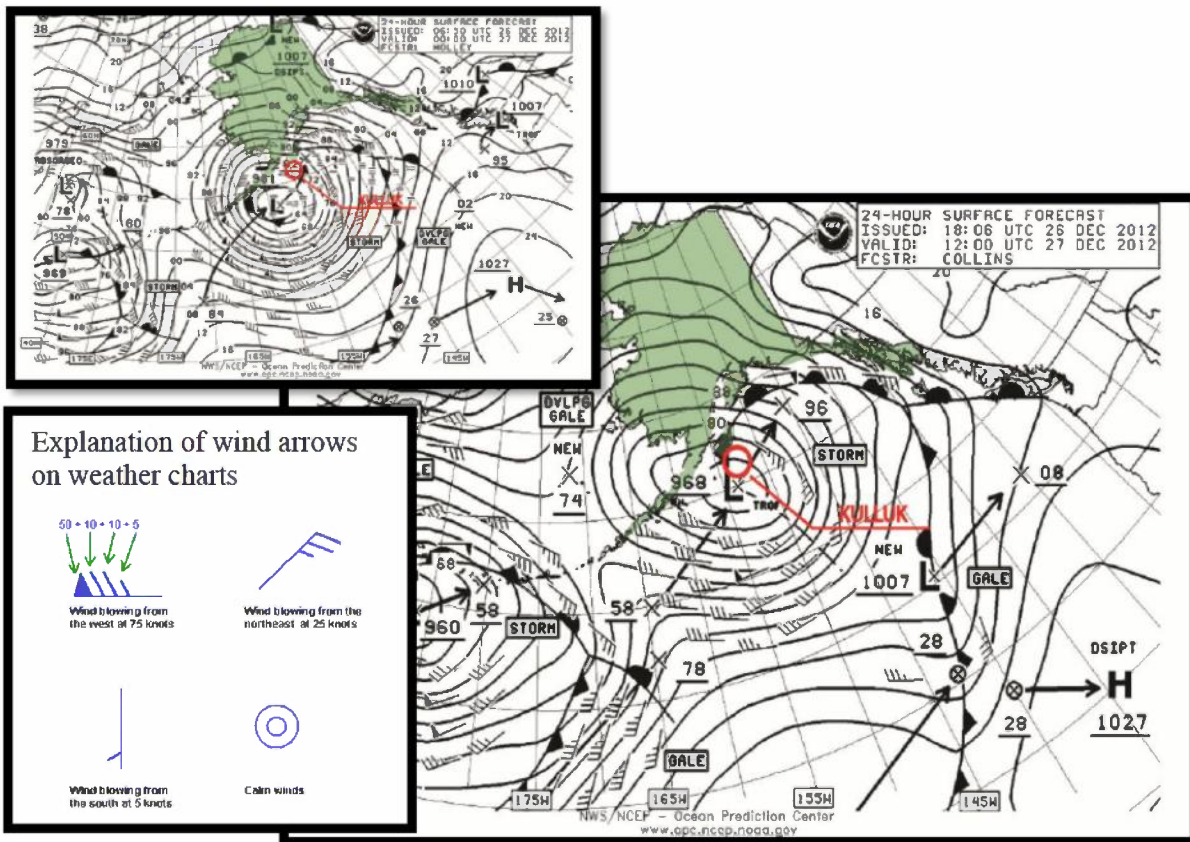


Figure 17: 24-hour NOAA surface forecasts for December 27. All times UTC. (NOAA surface forecasts with legend)

## Shackle Failure

77. By midnight on the evening of December 26, the AIVIQ, with KULLUK in tow, was located approximately 35 nautical miles southeast of the Trinity Islands, the southernmost group of islands adjacent to Kodiak Island, Alaska. On watch were 2<sup>nd</sup> Mate [REDACTED] and 3<sup>rd</sup> Mate [REDACTED] standing watch from 0000 hrs through 1200 hours. The AIVIQ continued towing the KULLUK on an approximate heading of 090 degrees, making between 2.6 and 3.2 knots ahead.<sup>57</sup> The KULLUK was being towed by the AIVIQ on the winch brake.

78. During the 0600 (time approximate) early morning discussion that took place on December 27 the AIVIQ Master and KULLUK Tow Master commented on some very significant vessel motion that occurred around 2200 on December 26. The Tow Master during the preliminary interview talked about the massive swell interacting with the shallower water of the 40 fathom bank that the tow passed over and making the comment that Captain [REDACTED] said, "I don't want to do that again".<sup>58</sup>

79. The AIVIQ changed to a more easterly course by mid-morning on December 27. According to the Tow Master, this change in course was to allow the AIVIQ to take a more southerly route in an attempt to move east away from an approaching weather system, and to keep weather systems to the north of the vessel's track. The course change was authorized by the Shell Marine Manager in response to an e-mail from the KULLUK Tow Master sent the morning of December 27, the contents as follows (Sent to Mr. [REDACTED] Edison Chouest and Noble were copied):

[REDACTED] n – Per our discussion, the Kulluk team and Aiviq are in agreement on the following: Considering both the shorter and longer range weather forecasts, the prudent course of action at this time is to run a Great Circle from our present position to rejoin our original track at the same latitude and at approx. 141.9W. This will allow us to gain considerable mileage to the East which we think very important for both potential refuge and a better ride should these strong Easterlies materialize next week. Please advise and thanks – [REDACTED]"<sup>59</sup>

80. The AIVIQ was equipped with a computerized towing control system. This system was located in the after portion of the wheelhouse on the centerline of the vessel. The sophisticated winch system would be used to pay out and retrieve wire, set and release the brake and to operate other towing drums. The system could monitor strain on the towing hawser as well as the hawser length. There was an alarm system built into the system which would enable the crew to customize the alarms for the specific towing application. One critical alarm was the tow strain monitor alarm. This alarm could be set at any metric ton of strain on the main hawser and would alarm audibly and visually if that strain was exceeded. The system was also equipped with a trend chart in case the watch team missed a spike in towing strain that occurred when they were not actually observing the monitor. There were also automatic, preset and manual alarms for the mechanical equipment for this winch system such as the hydraulic system and various motors.

81. During the morning of December 27, long period swells, in excess of 20 feet, were arriving from a generally southwestward direction, off the KULLUK's and AIVIQ's starboard quarter.

<sup>57</sup> As recorded in the AIVIQ's smooth bridge log and dynamic positioning data.

<sup>58</sup> Captain [REDACTED] Audio Interview, January 12, 2013.

<sup>59</sup> E-mail from Captain [REDACTED] dated December 27, 8:36 am.

82. Closed Circuit TV recordings and cell phone video captured the strain and dynamic loading of the towline over this period, which was indicated by periods of slackening and then tightening of the tow line. This visual evidence was consistent with movement of the tow line during the voyage in general. According to the AIVIQ logs and the computerized winch control the length of the AIVIQs towline was between 540 and 550 meters (1,771 and 1,804 feet)<sup>60</sup>, measured from the drum to the end of the AIVIQ hawser. The AIVIQ Master was aware that the bridge watch was paying out more wire and slowing the vessel in order to find the “sweet spot” for the tow, attempting to get the KULLUK more in step with the AIVIQ.<sup>61</sup> He communicated to the Tow Master that the AIVIQ would be slowing and lengthening the tow wire. Between the hours of 0500 hrs and 1100 hrs, on the morning of December 27, the AIVIQ paid out an additional 110 meters of towline from the AIVIQ’s winch due to increased strain on the towline.<sup>62</sup>

83. The 3<sup>rd</sup> Mate, Mr. ██████ took a cell phone video of the tow from the winch control station located in the after portion of the AIVIQ’s pilothouse during the morning hours of December 27, delivering this data to investigators during the formal hearing. The video shows the AIVIQ’s main deck, towline and KULLUK under tow. The video also pans down to show the winch control computer monitor, which displays the length and tension of the main tow wire. As the video shows the strain tension cycling up and down, displayed as a graph and numerically, ██████ states “*of course I’ll have to sit here and wait an [expletive] hour for this now.*” With the towline slack coming off the stern rollers on the AIVIQ’s back deck, the tension reading shows 35 tons. It then rapidly rises, as seconds later the tension from the towline increases to a maximum of 228 tons. As the tension reading increases quickly from 35 to 228 tons, he adds “*Here we go.*” Finally he adds “*That is a good quality piece of wire.*” The tension quickly falls to a low of 28 Tons. The video also shows that the length of the AIVIQ’s main towing wire to be 547 meters (1,794 feet). While the exact time the video was taken is unknown, the daylight evident in the video indicates that it occurred following sunrise, which was 0953 hrs. Figures 18 and 19 contain screen captures of this video.

84. Rolls-Royce, the manufacturer of the towing winch and the control system, analyzed data from the AIVIQ’s towing winch Towcon control system<sup>63</sup> after the casualty. The analyzed data indicated that between the hours of 0534 hours and 1129<sup>64</sup> on December 27 the alarm described as “wire tensile strength overload on tow drum” (Main towing drum utilized to tow the KULLUK) occurred on 38 separate occasions. According to Rolls-Royce, the alarm occurs when the load measured on the tow wire exceeds 50% of the breaking load set for the wire. The tow wire breaking load was set at 600 tons for this voyage, which means that the alarm would trigger only if 300 Tons or more tension was read by the strain monitors at the winch. Rolls-Royce representatives confirmed that this alarm would be both visual and audible, requiring watchstanders to acknowledge such an alarm on the Towcon main alarm computer screen. 3<sup>rd</sup> Mate ██████ stated that he did not recall receiving any of these alarms during his watch.<sup>65</sup>

85. Interviews with personnel on duty at the time of the towing gear failure stated that they felt the parting throughout the AIVIQ and that the event occurred without warning. At

---

<sup>60</sup> Towline length only includes the length of the AIVIQ’s towline proper, and does not include the surge chain, pennant wire, and bridle.

<sup>61</sup> Captain ██████ AIVIQ Captain, testimony before the marine investigating board, transcript page 1736.

<sup>62</sup> As recorded in the AIVIQ’s tow log.

<sup>63</sup> The onboard Towcon system logs certain occurrences that were extracted from the onboard memory unit and analyzed by Rolls-Royce.

<sup>64</sup> Edison Chouest was unable to provide the specific time zone by which the Towcon system alarms were recorded, following a request by the Coast Guard to provide this information. It is assumed that the times were local (AKST).

<sup>65</sup> Testimony of Mr. ██████ at formal hearing, transcript page 829.

approximately 1135 on December 27, the AIVIQ lost the KULLUK tow. See Figures 20 and 21. The KULLUK was adrift, approximately 52 miles east-southeast of Sitkinak Island.

86. The AIVIQ proceeded to retrieve the towline and it was discovered that the 120 ton shackle (Apex Shackle) that connected the pennant wire with the towing plate was missing. See Figure 22.

87. The KULLUK was able to recover the Towing Plate using the retrieval winch, and confirmed that this 120 ton shackle was in fact missing. The 120 ton shackle (Apex Shackle) connecting the AIVIQ hawser to the towing plate was lost at sea.



Figure 18: Screen capture from video showing tension reading of 28 tons on main tow drum. (Cell phone video screen capture provided by Mr. [REDACTED] AIVIQ Mate)

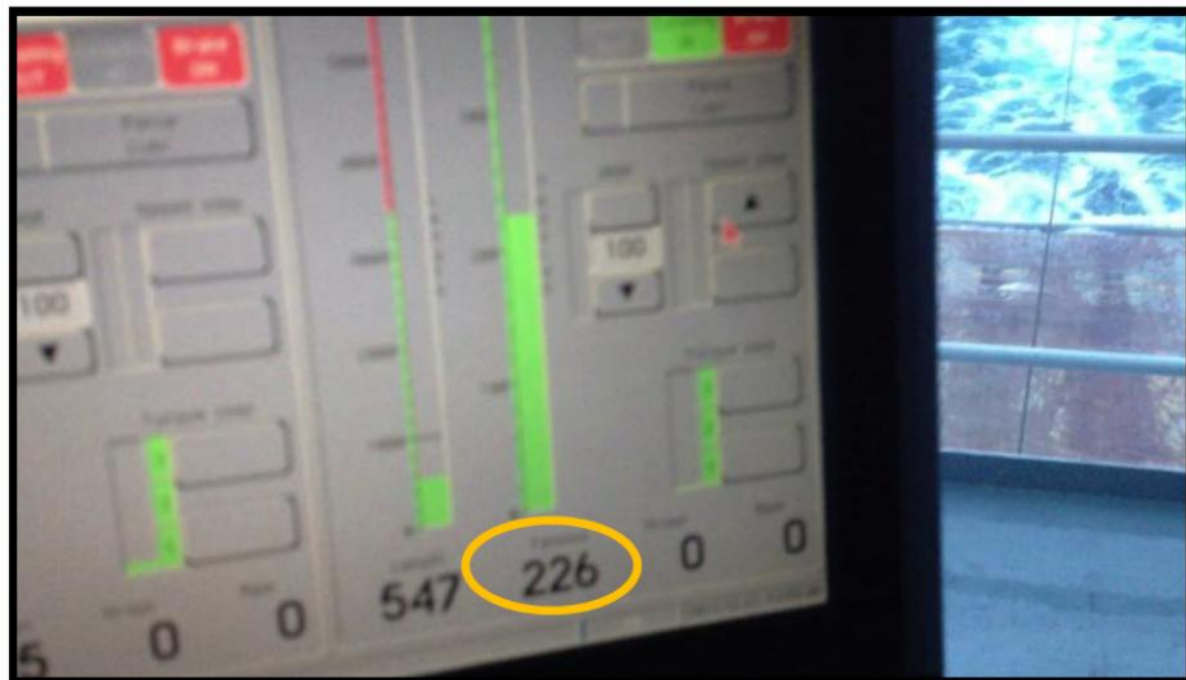
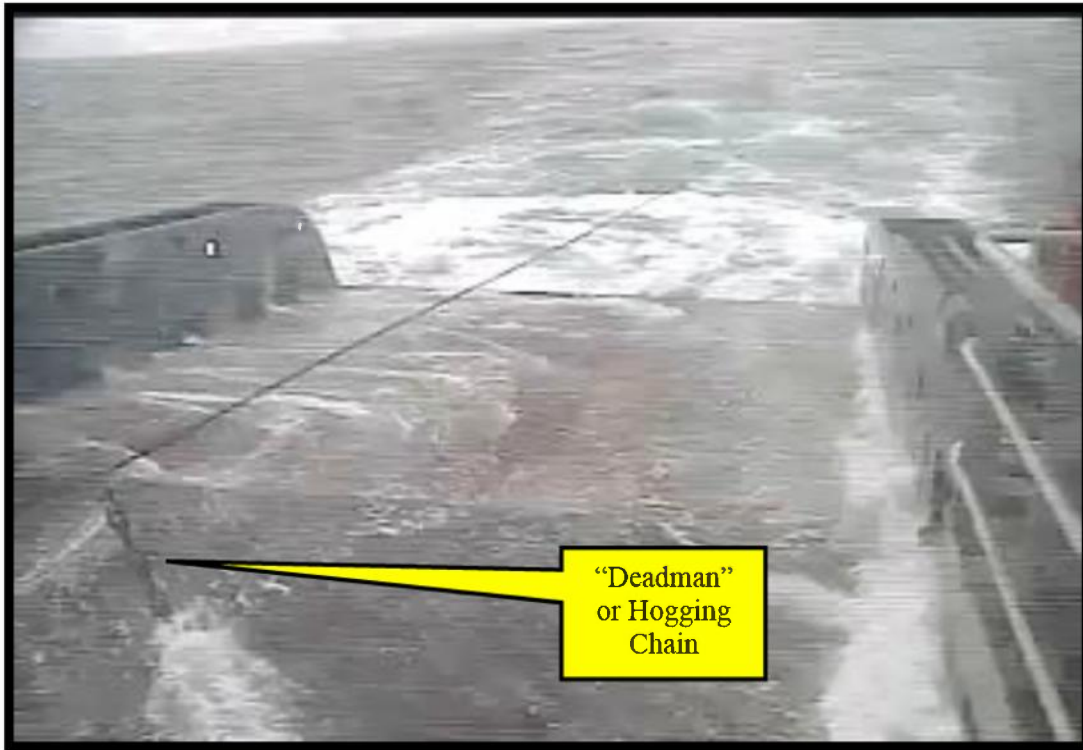


Figure 19: Screen capture from video showing tension reading of 226 tons on main tow drum. (Cell phone video screen capture provided by Mr. [REDACTED] AIVIQ Mate)



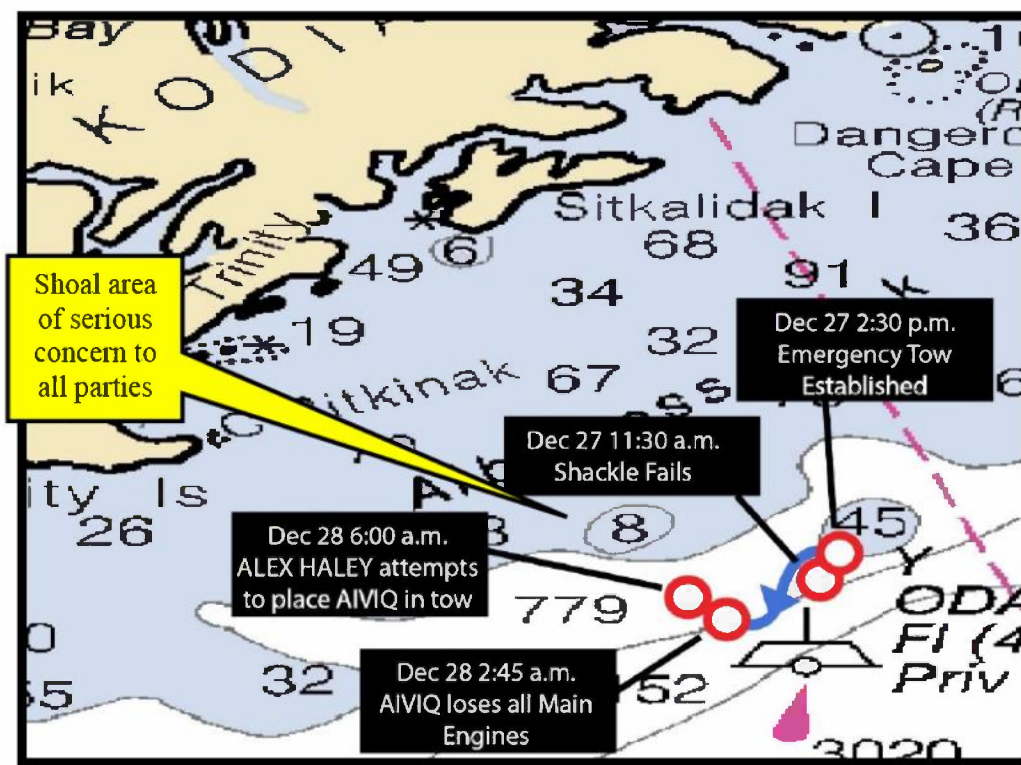
**Figure 20:** Screen capture of towline moments before failure of the shackle on the morning of December 27, 2012 (From AIVIQ CCTV recording and provided by ECO)



**Figure 21:** Screen capture of towline at moment of shackle failure on the morning of December 27, 2012 (From AIVIQ CCTV recording and provided by ECO)



**Figure 22:** Screen capture showing retrieved pennant wire and socket, missing shackle later in the morning of December 27, 2012. (From AIVIQ CCTV recording and provided by ECO)



**Figure 23:** Diagram shows approximate locations of KULLUK between 11:30 a.m. December 27 and 6 a.m. December 28.<sup>66</sup> Significant events are highlighted and times are approximate. Blue line indicates general direction and location of KULLUK during this period. (USCG analysis)

<sup>66</sup> Chart developed utilizing KULLUK AIS data and Edison Chouest Chart labeled Exhibit B as provided during the formal hearing.



### **Towing KULLUK on the Emergency Towline**

88. The decision was made to re-establish tow using the emergency towline as per the Shell Tow Plan. According to the Tow Master and the OIM, re-establishing tow utilizing the main towing line would require use of one of the KULLUK's cranes, which could not be safely used due to the sea state. The KULLUK cranes could only be used in ideal sea and wind conditions seldom found in the winter Gulf of Alaska conditions.

89. Shortly after the loss of the tow, the Shell Marine Manager was notified. Upon this notification the Shell Marine Manager notified Mr. [REDACTED] of the incident. Mr. [REDACTED] was the acting replacement for the Alaska Venture Operations Manager. After being apprised of the situation, Mr. [REDACTED] activated the Shell Incident Management Team (IMT). The IMT began to develop response and contingency strategies for this towing gear failure. One of the first actions taken was to locate assistance towing vessels and have them proceed to the KULLUK's position to support the AIVIQ. The Coast Guard was also notified.

90. The KULLUK was rigged with an emergency towline as required in the Shell Tow Plan. The emergency towline was rigged and ready onboard KULLUK in Dutch Harbor prior to the voyage and was designed so that a towing vessel could re-establish tow following a failure of the primary towing gear. The emergency towline system was connected onboard the KULLUK via a Smit bracket, located at the "stern" of the conically shaped vessel, below the helicopter deck. The emergency towing system was appropriately rigged and ready for use.<sup>67</sup> Because the KULLUK was manned, the emergency towline was not deployed into the water until the AIVIQ made her approach, at which time the float and messenger line were deployed to allow pickup by the AIVIQ.<sup>68</sup>

91. After retrieving the towline the AIVIQ returned to the KULLUK to retrieve the emergency towline and place the KULLUK in tow. During their approach, the AIVIQ took a significant roll, due to sea swells in excess of 25 feet. During this roll, the J-Hook (a heavy piece of marine hardware) broke free from its housing in the upper deck area, causing minor damage to handrails, vents and the superstructure. Large steel spherical anchor balls also broke loose and had to be secured. The Chief Engineer welded the J-Hook to the deck to secure the device.

92. During certain sea conditions and when the AIVIQ was excessively rolling large amounts of sea water shipped aboard the main deck of the vessel. That water entered the "safe deck area" which ran down the sides of the main deck. These safe deck areas ran the length of the open main deck and along with other equipment they contained multiple vents for the fuel oil system. These vents were approximately 34 inches off the main deck.

93. Again the AIVIQ approached the KULLUK to retrieve the KULLUK's floating messenger and the emergency towline which had been released by the KULLUK crew. At the end of this emergency towline messenger was a round buoy float. The AIVIQ retrieved the messenger line with a thrown grapple hook and began to make the connection of the emergency towline fast to the AIVIQ's tow hawser by use of an appropriately secured shackle.

---

<sup>67</sup> The KULLUK did not have a bow or stern per se, being truly conical in design. According to the vessel's operations manual, the stern is the portion of the KULLUK at the helicopter deck.

<sup>68</sup> Had the KULLUK sailed unmanned, the emergency towline would have been rigged in such a manner that the messenger line and buoy would trail in the water behind the towed vessel and be ready for unattended retrieval.

94. At approximately 1430 on December 27, the AIVIQ had the KULLUK in tow utilizing the emergency towline. The AIVIQ's towline, which consisted of the recovered surge chain and pennant wire configuration from the original tow, was connected to 400 ft. of *Samson Saturn® 12*, 3 ¼ inch diameter rope, which in turn was connected to a short chain secured to the Smit Bracket on the KULLUK's stern. 120 ton Van Beest shackles were used for all connections, with the lone exception of a single 85 ton shackle which made the final connection to the Smit bracket. This configuration was supported by examination of the retrieved equipment off the KULLUK following the casualty.

95. In order to reduce stress on the towline and associated connections, and after consultation with the KULLUK Tow Master, the AIVIQ reduced their engine power and attempted to maintain a tension of not more than 60 tons.<sup>69</sup> The AIVIQ Captain believed the recommended reduction in propulsion was due to the concern over a shackle that made up part of the emergency towing configuration. The tension of the tow was monitored by the AIVIQ bridge crew using the Towcon tension monitoring system as well as visually monitoring the catenary of the wire.

96. Once the emergency tow was connected, the AIVIQ proceeded on a generally south-westerly course to keep increasing the distance away from Albatross Bank and an eight fathom shoal area (see Figure 23), which was north of their position. This shoal area was of serious concern due to the interaction of the sea and swell height and the 10.7 meter draft of the KULLUK.

97. Following the connection of the emergency towline, the KULLUK crew rigged another makeshift towline as a contingency. According to the Tow Master, the intention was to create a backup to the emergency towline. This additional emergency towline was then rigged, made up primarily using a synthetic line that the crew located onboard the KULLUK with three life rings as floats. It was not deployed at the time but was available and standing by should the need arise.

98. Following the establishment of the emergency towline, Shell began to reach out to those vessels under contract and other operators in the area for assistance.<sup>70</sup> At the request of Shell, both the Crowley Marine Services towing vessel GUARDSMAN and the Edison Chouest Offshore Supply Vessel NANUQ were ordered to depart Seward, Alaska to provide assistance. The GUARDSMAN departed Seward at approximately 1415 on December 27 and the NANUQ departed at approximately 2355 that evening. The NANUQ had to make arrangements for a pilot to take her to sea in accordance with a local harbor regulation.

99. At approximately 1520 on December 27, the U.S. Coast Guard Cutter ALEX HALEY was ordered to proceed to the KULLUK's location. The CGC ALEX HALEY was underway on patrol at the time in the vicinity.

100. By 1800 on December 27 the wind had diminished to approximately 10 – 15 knots from the WSW, yet the seas remained heavy, with 18 – 20 foot seas and occasional 30 foot swells.

---

<sup>69</sup> Captain ██████████ testimony at Formal Hearing, transcript page 1666 – 1667.

<sup>70</sup> Interview with Ms. ██████████ Shell Alaska Logistics Manager.

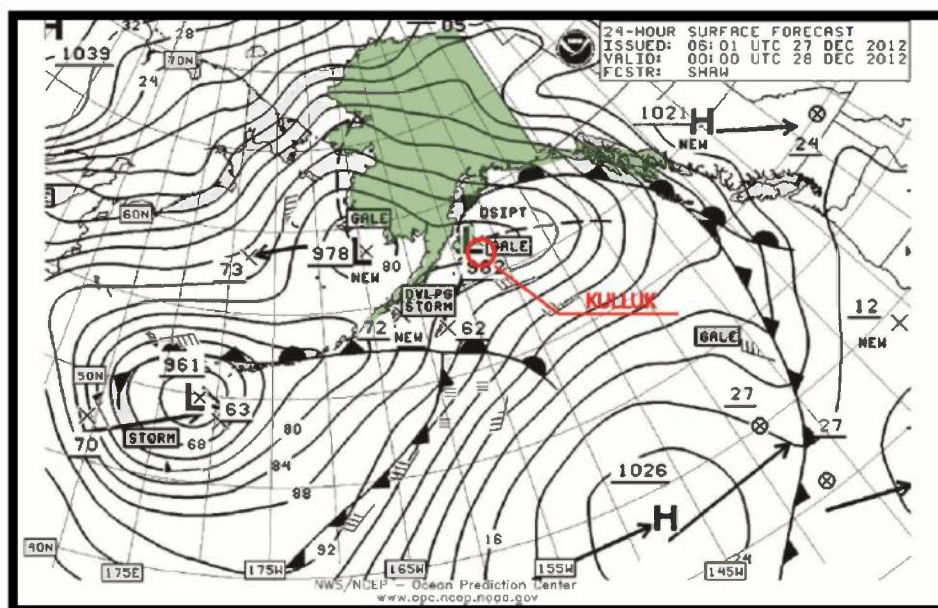


Figure 24: 24-hour NOAA surface forecast for 0000 hrs December 28. All times UTC. (NOAA surface forecasts published on the internet and the Alaska portion of the map highlighted for clarity)

### AIVIQ Main Propulsion Failures

101. The AIVIQ loaded approximately 443,000 gallons of Ultra Low Sulfur Diesel fuel on December 20 at Delta Western in Dutch Harbor. This fuel was provided by the tanker AFFINITY. An additive, *Stadis 450* was added to the fuel to prevent the generation of static charges. There is no evidence of additional additives, such as biocides that may have been added by the AIVIQ crew or other parties.<sup>71</sup>

102. Tank Level Indicator (TLI) data<sup>72</sup> shows rapid filling of the Fuel Oil Overflow Tank from approximately 1000 gallons to over 4,000 gallons (with 4,597 gallons being the design capacity of the tank) during the morning hours of 28 December. However the TLI data time reference may not relate to the actual time of filling and statements of the 1<sup>st</sup> Assistant Engineer indicate that the Fuel Oil Overflow Tank was full prior to the failures of the main engines. On January 3, 2013, the Fuel Oil Overflow Tank was pumped into the #2 Fuel Oil Storage Tank. Using water gauging paste, the crew estimated that the Fuel Oil Overflow Tank contained nearly 1,832 gallons of water.<sup>73</sup>

103. AIVIQ engineering logs indicate that at 1000 on December 27 the #1 Port and Starboard Day Tanks and Settling Tanks were “Color Cut”<sup>74</sup> and were found “All OK.” Later in the day,

<sup>71</sup> Marine Safety Center Analysis of M/V AIVIQ Marine Casualty document dated 26 November, Appendix 1 page 3.

<sup>72</sup> TLI data was provided by Edison Chouest Offshore and the time reference in this data could not be verified as AKST or CST ( the time reference for ECO’s remote monitoring site in Louisiana)

<sup>73</sup> Marine Safety Center Analysis of M/V AIVIQ Marine Casualty document dated 26 November page 7.

<sup>74</sup> “Color Cut” is a process of using “Kolor Kut” paste that will indicate the presence of water, and is commonly utilized in the marine industry.

logs indicate that the aft fuel oil purifier “was processing less than 7 gallons per minute after all the water.” Another entry in the engineering smooth log indicates “traces of water” were detected in the settling and #1 Day Tanks. These entries all occurred prior to the loss of any engines.<sup>75</sup>

104. At approximately 2255 on December 27, the #2 main diesel engine (MDE) of the AIVIQ was intentionally shut down to check lube oil levels due to the leak from the oil pan. After checking the oil level the engineers were unable to restart that engine. Soon afterward, the AIVIQ engineers monitoring the engine performance displays noticed that engine temperatures indicated that the injectors were failing on all engines. At approximately 0145 on December 28, the #3 and #4 MDEs shut down. Finally, at approximately 0245 December 28 the #1 MDE shut down as well. At this point the AIVIQ was now maneuvering using their 2,600 horsepower directional azimuth thruster and three of the four tunnel thrusters as their only means of propulsion. One of the after tunnel thrusters was not operable. All thrusters operated off electrical generator power provided by the ships service diesel generators.

105. While the exact number of spare injectors onboard is not certain, the Chief Engineer believed they carried six spares onboard. The engineering crew began to replace the failed injectors on the #1 MDE with the onboard spares in an attempt to return that engine to service. This investigation did not identify classification society or manufacturer recommendations with respect to the number of spare injectors to be kept onboard.

106. At the time of the loss of the MDE's the AIVIQ was running their engineering plant in a split configuration. The Port MDE's and Generators were receiving fuel from the #1 Port Day Tanks, and the Starboard MDE's and Generators were receiving fuel from the #1 Starboard Day Tank.

107. With the engine failure of the AIVIQ, the vessels began being driven towards the westerly then north-westerly direction by the winds and the seas. During this period the KULLUK remained under tow at a greatly reduced towing capacity. With the main propulsion system experiencing failures, the AIVIQ could no longer maintain headway and began to be pulled astern by the combined forces of the sea and wind on the KULLUK while maintaining directional heading. The azimuth and tunnel thrusters were able to keep the AIVIQ's bow into the seas and the AIVIQ away from the KULLUK. The movements of the vessels during this time can be attributed to the prevailing westerly current<sup>76</sup> in the area combined with a 25-30 knot southwesterly wind.<sup>77</sup>

108. On December 29, AIVIQ's Ship Service Diesel Generator (SSDG) fuel injectors also began to fail. These SSDG injector failures were of a different nature than the main engine injector failures. The SSDG injector failures were a breakdown of the o-rings causing dilution of the lubrication oil. According to ship's logs, “Small amounts of water and small amounts of slime” were found in the #2 Generator primary Racor Filters. Also according to the ship's logs, on January 1, “small amounts of slime” were found in the secondary filters.<sup>78</sup> There is no indication that the problems caused a loss of a generator during this incident, though replacement of generator injectors was necessary to prevent such losses.

---

<sup>75</sup> Marine Safety Center Analysis of M/V AIVIQ Marine Casualty document, Appendix 1, dated 26 November, 2013, page 3.

<sup>76</sup> Coast Pilot 9- Pacific and Arctic Coasts Alaska: Cape Spencer to Beaufort Sea.

<sup>77</sup> From 0000 hrs 28 December logbook entry of the KULLUK.

<sup>78</sup> Marine Safety Center Analysis of M/V AIVIQ Marine Casualty document, Appendix 1, dated 26 November, 2013, page 4.

### Arrival of the CGC ALEX HALEY

109. At approximately 0130 on December 28, the CGC ALEX HALEY arrived on-scene with the KULLUK and AIVIQ. Following the loss of the main engines, the Master of the AIVIQ and the Captain of the CGC ALEX HALEY decided that the best course of action would be for the ALEX HALEY to place the AIVIQ in tow connected to the KULLUK in order to ensure the AIVIQ maintained control over her heading. The AIVIQ was concerned that should the generators powering the thrusters fail, the vessels and crew would be in imminent danger. The AIVIQ remained connected to the KULLUK via the emergency towline configuration.

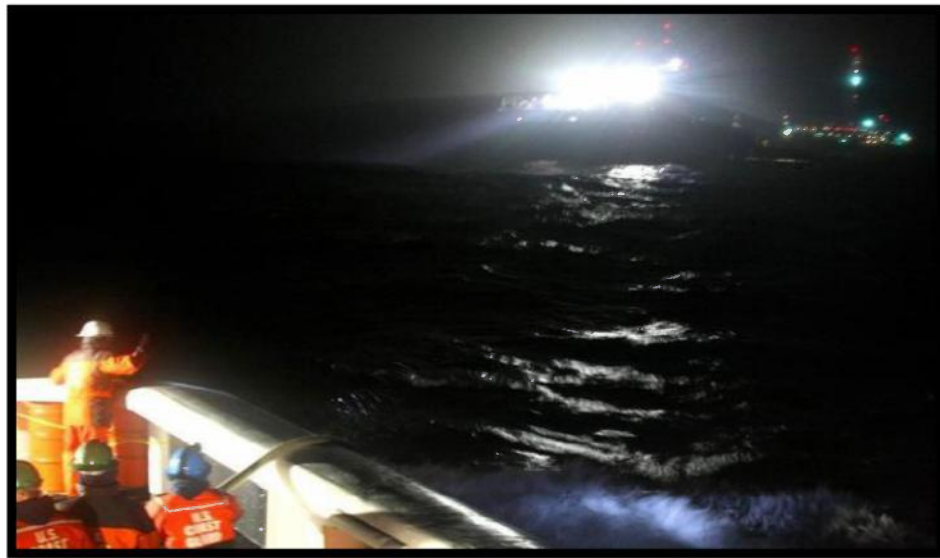
110. During recorded radio conversations between the AIVIQ Master and the CGC ALEX HALEY the Master of the AIVIQ explained that, *“heavy weather yesterday might have taken on some water in our fuel”* and *“port mains are showing some signs of water intrusion as well”*<sup>79</sup>. During testimony, the AIVIQ Master stated that his remarks should be attributed to a miscommunication between himself and the AIVIQ Chief Engineer, and that water intrusion was not confirmed to be the cause of the engine failures.

111. The AIVIQ crew rigged the emergency bow towing bit for towing operations. The CGC ALEX HALEY maneuvered in close to the bow of the AIVIQ, and began to pass a manila and nylon messenger over to the AIVIQ<sup>80</sup>. This was connected to the ALEX HALEY’s heavy nylon hawser being heaved to the bow of the AIVIQ. Crewmembers aboard AIVIQ were hauling the messenger line in during high seas and attempting to overcome the height difference between the stern of the cutter and the high bow of the AIVIQ. During this hauling in, there was a significant difference in the drift rates of the CGC ALEX HALEY and the AIVIQ, causing the two vessels to drift apart despite their maneuvering to stay relatively close together. During this period the CGC ALEX HALEY paid out more towing hawser believing that the hawser had actually been made fast to the AIVIQ’s bow. This hawser was paid out by the cutter to a point where the messenger and hawser became entangled in the propellers of the CGC ALEX HALEY. The AIVIQ reported parting of the manila messenger line and almost simultaneously the fantail of the CGC ALEX HALEY reported the towline going from slack to full tension. Due to the hawser originally leading from the starboard quarter of the CGC ALEX HALEY to the water it was thought that the hawser fouled the starboard screw. Evaluation of the situation revealed that the starboard screw was clear but that the port screw was fouled with approximately 800 feet of messenger line and the heavy nylon towing hawser. Because of the sea conditions and resultant safety concerns no attempt was made to remove the fouled messenger and or towline. By 1100 on December 28, the CGC ALEX HALEY was ordered to return to Kodiak for repairs.

---

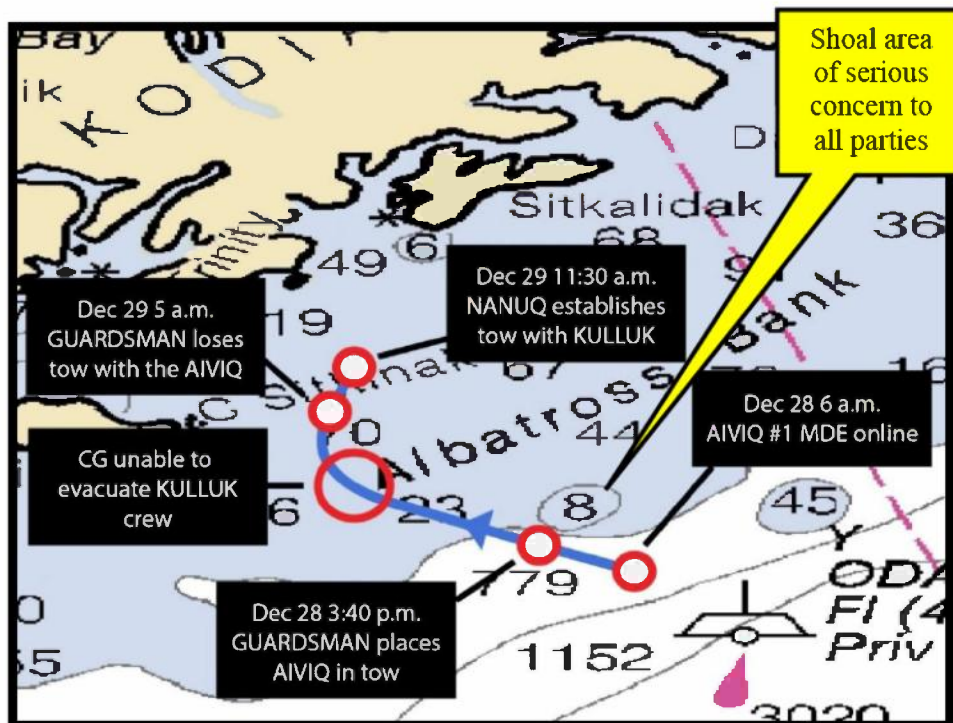
<sup>79</sup> VHF Radio communications recorded by the USCG at the USCG Sitkinak High Site at approximately 0114 December 28, Quotes attributed to AIVIQ Master, Captain [REDACTED]

<sup>80</sup> This messenger was delivered to the AIVIQ via a line throwing gun fired from the HALEY. The messenger was attached to a lighter line that was hauled over to the AIVIQ as the operation commenced.



**Figure 25:** The crew of the USCGC Alex Haley attempt to pass the towline to the bow of the AIVIQ. Bright lights are located on the bow of the AIVIQ and the KULLUK is in the distance at the far right of the photograph. (USCG Photo)

**Guardsman & Evacuation Attempt**



**Figure 26:** Diagram shows approximate locations of KULLUK between 0600 hrs December 28 and 1130 December 29. Significant events are highlighted. (USCG analysis)

112. The engineering crew of the AIVIQ was able to replace five (5) of the failed injectors on the #1 MDE with onboard spares and by approximately 0600 on December 28, the #1 MDE was operational and able to provide propulsion to the port shaft, though the overall load on the engine was reduced due to continued injector concerns. With no spare injectors remaining onboard the AIVIQ, no further repairs were able to be made. The engineering crew then configured the #1 MDE to be fed from the #2 Port Day Tank, as fuel contamination was considered the most likely cause of the engine failures. The Chief Engineer was then able to recirculate the #2 Port Day Tank fuel through the fuel oil purifiers providing a clean fuel source.

113. With limited power on their #1 MDE and rotating azimuth and tunnel thrusters, the AIVIQ continued to be pulled astern by the KULLUK's wind driven drift, and the vessels were drifting slowly to the northwest. There was considerable concern that the KULLUK would drift on a marked 8 fathom area (see Figure 26), in which there was a chance that the KULLUK would ground or touch bottom in the seas. The drift of the KULLUK narrowly missed this area by approximately 8 miles, drifting to the west of this shallow bank.

114. At approximately 1329 on December 28, the tug GUARDSMAN arrived on-scene. The GUARDSMAN assessed the situation and made preparations to take the AIVIQ in tow with the KULLUK being towing astern.

115. At 1538 the connections were made fast and GUARDSMAN was towing the two vessels astern. The GUARDSMAN had approximately 2,200 feet of 2 1/4 inch tow wire connected to 1 1/2 shots (135 feet) of 3 inch surge chain, and 450 feet of 7 1/2 inch synthetic emergency towline utilizing 3 inch shackles. The emergency line was shackled into a short piece of synthetic line (AmSteel Blue<sup>81</sup>) prepared onboard the AIVIQ, this lead through the bullnose chock on the AIVIQ's bow. Onboard the AIVIQ, that short Amsteel Blue line was connected to the vessels emergency towing bit which was located on deck on the bow. The GUARDSMAN was now towing the AIVIQ, which is still connected to the KULLUK via the emergency towing configuration.

116. Once the towline was established between the GUARDSMAN and AIVIQ, the GUARDSMAN pulled with her towline to keep the AIVIQ's bow into the sea with as much power as she could maintain during worsening weather conditions. In order to maintain course into the weather, the GUARDSMAN had to maintain about 25 degrees left rudder, and experienced cavitations of her propellers. During much of this towing operation, the GUARDSMAN reported being pulled backward by the AIVIQ and KULLUK at a drift rate between 1 – 2 knots. The GUARDSMAN, AIVIQ towing KULLUK were set as a single group to the west northwest, moving towards Sitkinak Island. When the group of vessels came to within 9 miles of the island, the set or direction of movement of the vessels changed to a more northerly direction, taking them perpendicular to the island. This change in drift and course direction coincided with the backing of the wind to a more southerly direction during the early morning hours of December 28.

---

<sup>81</sup> AmSteel®-Blue is a torque-free 12-strand synthetic single braid that yields the maximum in strength-to-weight ratio and, size-for-size, is the same strength as steel—but it's so light, it floats.

Time	Wind	Seas
1300 28 Dec	20 SE	8 - 12
1900 28 Dec	35 – 45 SE	10 - 12
2300 28 Dec	35 – 45 S	12 – 20 S
0300 29 Dec	50 S	20 - 25

Figure 27: Weather data as recorded by the GUARDSMAN (USCG extracted and analysis)

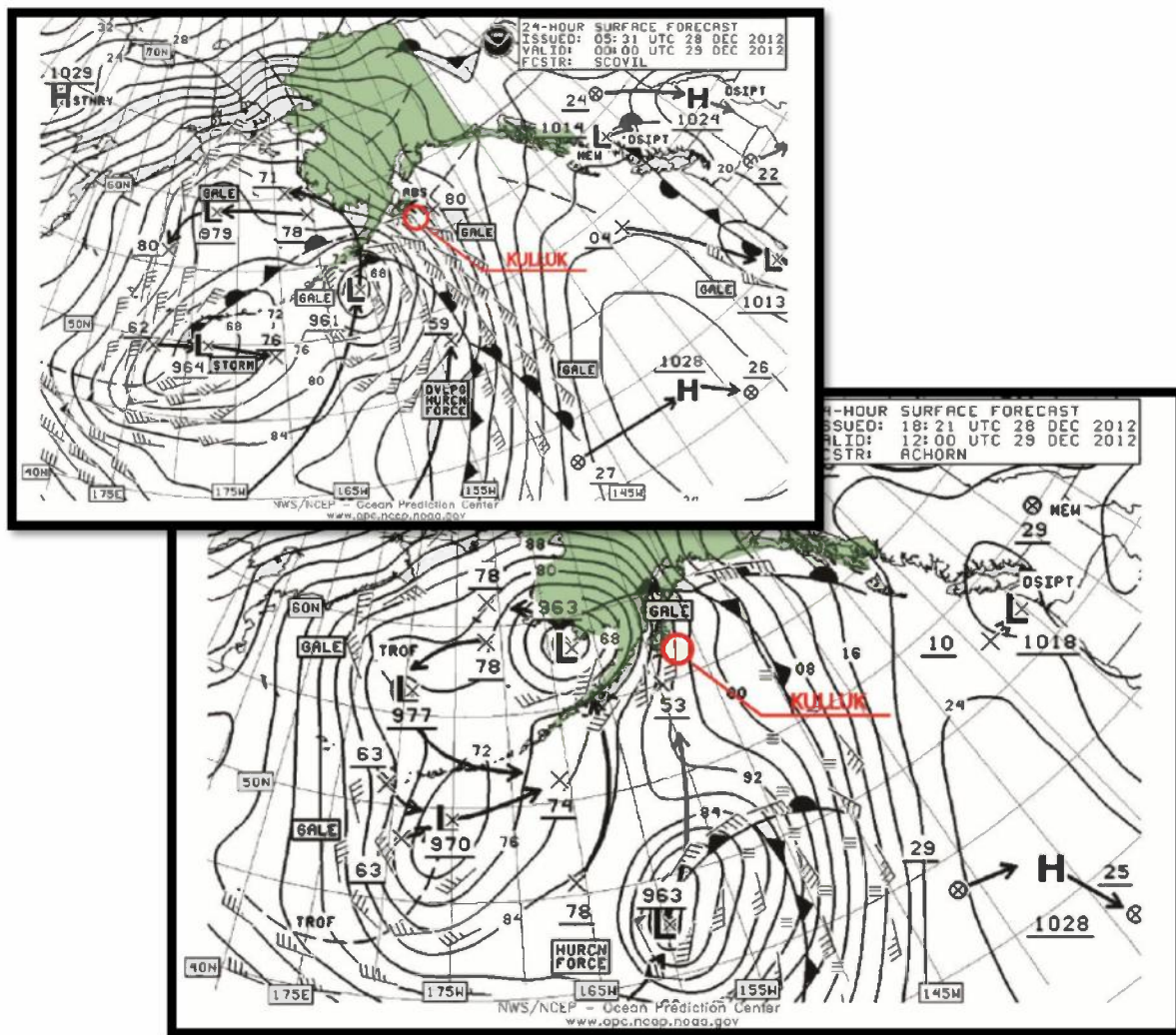


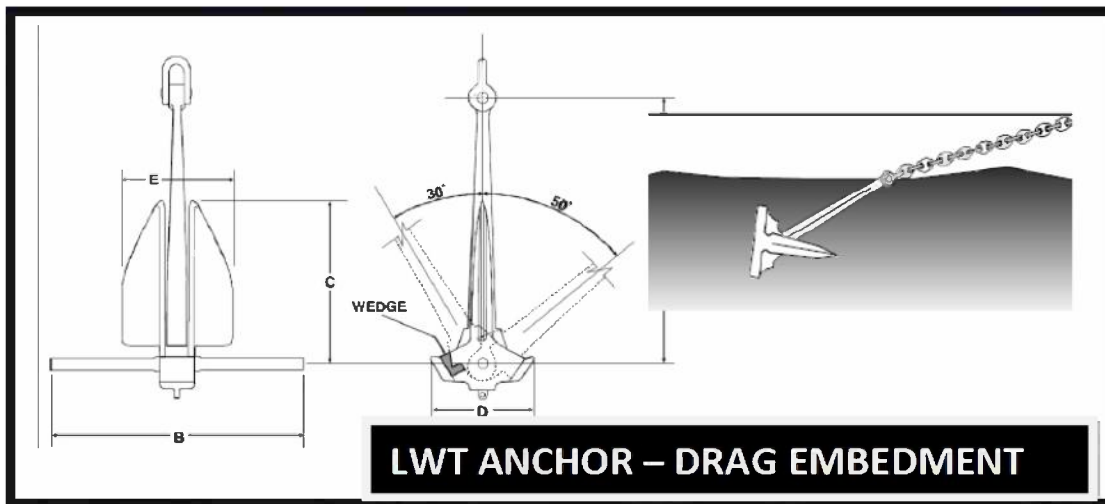
Figure 28: 24-hour NOAA surface forecast for 0000 and 1200 December 29. All times UTC (NOAA surface forecasts published on the internet and the Alaska portion of the map highlighted for clarity)

117. The critical nature of events during the evening of December 28, resulted in the Shell Incident Management Team being upgraded to a Unified Command structure with expanded participants. A Unified Command was established to coordinate both vessel response and potential oil recovery operations. The initial Unified Command consisted of representatives of



the Coast Guard (Federal Onscene Coordinator), Shell (Incident Commander) and Edison Chouest. The composition of the Unified Command would later be expanded to include Noble Drilling, State of Alaska and Kodiak Borough.

118. At approximately 2100 on December 28, Shell requested that the Coast Guard evacuate all 18 persons from the KULLUK via Coast Guard helicopter assets. Evacuation under these conditions would involve a night time evacuation under extremely adverse weather conditions. In preparations for the evacuation, the crew of the KULLUK put on flight dry suits, issued to each crewmember by Shell prior to departure from Dutch Harbor. By 2250 Coast Guard helo CG-6044 arrived on scene with KULLUK and reports winds between 35 – 45 knots and 18 foot swells. An additional helicopter, CGR-6010 arrived on scene shortly afterward. Due to the darkness coupled with the excessive pitching and rolling of the KULLUK, it was considered too dangerous to safely hoist personnel. At the time of the rescue attempt, the KULLUK was pitching up to 30 degrees and the heaving nearly 50 feet vertically in the extreme weather. According to both the OIM and Tow Master, use of the lifeboats was considered, but this evacuation method was ruled out as it was extremely dangerous due to the sea conditions at the time.



**Figure 29:** Diagram of a LWT anchor of a similar type carried aboard the KULLUK. The survival anchor was a 15 ton anchor. (Diagram U.S. Navy Towing Manual composite)

119. The KULLUK was fitted with one survival anchor which was fitted with the typical ground tackle for a ship's anchor such as hawsepipe, brake and securing device. The windlass for the anchor was located in a compartment on the KULLUK and the chain led out from the windlass onto the deck and then through a hawsepipe to the sea below. The anchor and windlass are located near the starboard quarter of the KULLUK, near the "stern" on the main deck in relatively close proximity to the helicopter deck area which was on the opposite end of the vessel from the main towing equipment, or the "bow" of the KULLUK.



**Figure 30:** The anchor chain for the survival anchor leading out of the windlass room towards the hawsepipe. (Photo provided by Shell)

120. After the towing gear failure that occurred on December 27 the anchor was reported to have been dropped on two occasions. In one occasion this was as the result of a miscommunication between the KULLUK OIM and Tow Master and the crew of the KULLUK in a high stress situation. The anchor was released then quickly recovered. At this time the anchor was lowered to a reported depth of approximately two to three shots of chain or approximately 180 to 270 feet.

121. In the second occasion the OIM reported that the survival anchor was intentionally deployed to the bottom and was retrieved approximately six hours later. At this time the towing operation was near Albatross Bank a relatively shallower area of water 12-40 fathoms with a rocky bottom and areas of broken gravel. Nearer to the shore the water deepened with a mud bottom. According to the Van den Haak R study<sup>82</sup> the LWT anchor is not ideal for coarse gravel or rocky bottom. When the anchor was retrieved the OIM reported that he believed the anchor was on the bottom and as evidence he said the last links of chain were “shiny” which he attributed to dragging on a rocky bottom. This statement is supported by HSE Technician [REDACTED] in his interview statement.

122. The KULLUK Tow Master in both his initial interview and formal interview stated that each deployment of the anchor as a result of miscommunication and the anchor was quickly retrieved. His account differed from the OIM account and testimony from the HSE Tech, Mr. [REDACTED]

<sup>82</sup> Van den Haak R. ‘Anchors’. Holland Shipbuilding International, October 1972. In the following study, OTH 93 395 **DRAG ANCHORS FOR FLOATING SYSTEMS** Authors: P Sincock and N Sondhi MSL Engineering Ltd Technology Transfer Centre Silwood Park Buckhurst Road Ascot Berkshire SL5 7PW HSE BOOKS

123. Prior to evacuation, a plan was put together by the Unified Command and KULLUK personnel that involved dropping the survival anchor immediately prior to evacuation. During the late evening of December 28 the 15 ton survival anchor was deployed to an undetermined depth below the bottom of the KULLUK. There is conflicting testimony relating to the circumstances of the deployment and the depth of deployment. One line of testimony states that the anchor was dropped based on miscommunication aboard the KULLUK and it was quickly recovered. The other line of testimony is that the anchor was dropped to the bottom and it remained there for an undetermined period of time and that this was an intentional act. It is not clear if the anchor ever held or grabbed on the bottom of the sea. The effect of the anchor acting as a “drogue” (similar to a sea anchor) and influencing the towing operation cannot be determined. Mr. [REDACTED] (Noble Drilling UC representative), noted that the Unified Command authorized deployment of the anchor following the unsuccessful evacuation attempt. Mr. [REDACTED] understood that the survival anchor was deployed to an indeterminate depth at that time, and the full scope (900 feet) was deployed following the loss of the Guardsman’s tow at approximately 0500 December 28. The survival anchor was recovered prior to the evacuation on December 29.

124. At 0151 on December 29 the Unified Command released the following update:

***“Update #4: Unified Command authorizes Kulluk to drop anchor to slow drift***

*As a precautionary measure Unified Command authorized crew members of the Kulluk to drop its anchor off the coast of Kodiak. This tactic is used to slow the drift of the Kulluk and minimize potential impact to personnel and the environment. The Aiviq and Guardsman, as an additional precautionary measure, were still connected to the Kulluk during the time of the anchor deployment. Teams are currently evaluating the trajectory of the Kulluk drift and impact of the anchor deployment.”*

125. Edison Chouest shore side support personnel procured replacement injectors from various locations throughout the U.S. and had them flown via corporate jet to Air Station Kodiak for delivery to the AIVIQ. Between the hours of 0300 and 1000 on December 29, Coast Guard Helicopters from Air Station Kodiak delivered replacement injectors to the AIVIQ via multiple hoisting operations with twelve baskets of parts hoisted. During this period, approximately 74 injectors were delivered to the vessel. The AIVIQ crew immediately began to replace the failed injectors with the recently delivered replacements.



**Figure 31:** A USCG helo makes night time delivery of engine parts to the helicopter deck on the AIVIQ (USCG Photo)

126. On December 29 at approximately 0425 hrs, the Crowley Marine towing vessel ALERT departed Port Etches, near Valdez, Alaska, to assist the KULLUK as per Shell's request.

127. According to the Master of the GUARDSMAN, at approximately 0500 hrs on December 29, the GUARDSMAN's backward motion stopped. Almost immediately the GUARDSMAN began to make forward progress at a speed of approximately 1 ½ knots. After moving forward a minute or two, the GUARDSMAN rode over a 30 foot swell and parted its tow wire to the AIVIQ. The wire, line and connections were "cut away" from the bow of the AIVIQ and fell into the sea clear of the vessel to ensure the line would not foul the AIVIQ's azimuth thruster. The AIVIQ was now the lone vessel towing the KULLUK.

128. At this point the GUARDSMAN stood by in close vicinity ready to assist in any way possible. With no other surge chain or shock line aboard, the Master did not consider the Guardsman able to conduct further towing operations.

#### *NANUQ Provides Assistance*

129. At approximately 0630 hrs on December 29, the NANUQ arrived on-scene with the KULLUK, AIVIQ and GUARDSMAN. Waiting for daylight the NANUQ assessed the situation and prepared for towing operations. The NANUQ did not have surge chain or elastic shock line aboard so the crew attempted to fabricate a component to put between the KULLUK line and their tow line. They constructed a "grommet" utilizing a doubled over length of 3 ½ inch nylon which would resemble a large rubber band then completed. The Master of the NANUQ was concerned with his ability to safely tow the KULLUK without this component in the towing system.

130. Personnel aboard the KULLUK had identified that the best method for the NANUQ to tow the KULLUK was with one of the vessels mooring /anchor wires. There were 12 of these wires located around the perimeter of the conical rig. These wires passed from a winch down into the open center of the rig and then were put through a fairlead and then led up to the railing around the perimeter of the rig. This was their stored position. The crew selected the #8 mooring wire because it was located near the attachment point for the emergency towline under the helicopter deck area. This arrangement would allow NANUQ to tow the KULLUK with the AIVIQ already engaged in towing.

131. After daylight, the NANUQ successfully used a line throwing gun to pass a messenger line to KULLUK. This line was connected by KULLUK crew to the eye of the #8 mooring wire, which was in a sling on the main deck. Following connection, the NANUQ retrieved the #8 wire from the KULLUK and connected it to their 2 ¼ towing wire using a 150 ton shackle with

appropriate fastening. The tow was made fast at approximately 1130 hrs and the connection was made without surge or shock gear in the tow line. The grommet was not utilized at the request of the Tow Master because there was no testing or strength rating information available for this component. With the AIVIQ and NANUQ both towing the KULLUK, both vessels are able to make forward progress against the sea and wind conditions in a southerly direction, away from Sitkalidak Island.



Figure 32: NANUQ on the left and AIVIQ on the right side of the photo with the KULLUK under tow in the distance (USCG Photo)

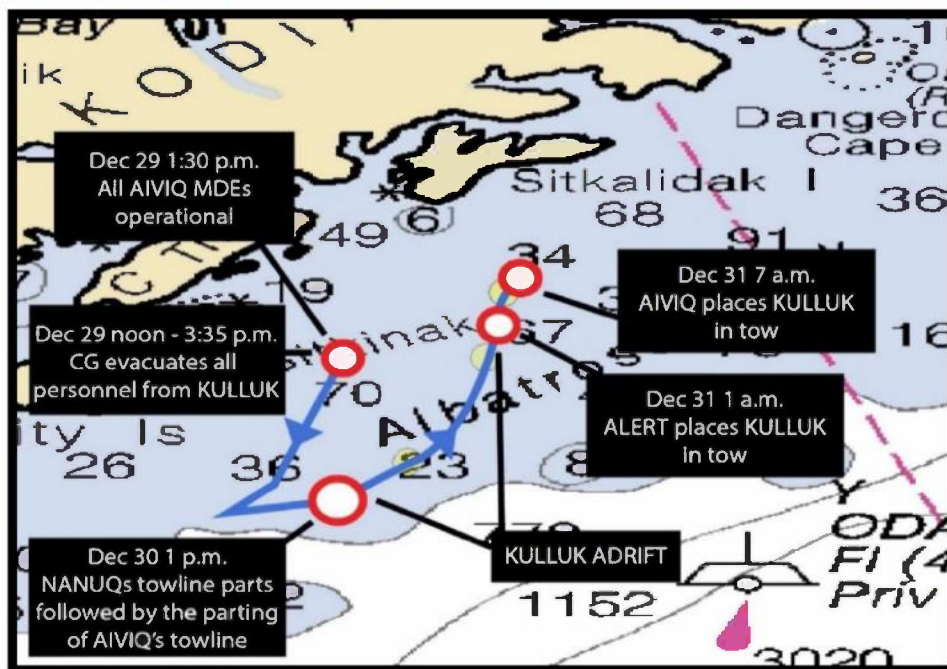


Figure 33: Diagram shows approximate locations of KULLUK between 1200 hrs December 29 and 0700 hrs December 30. The blue line indicated general direction and location of KULLUK during this period. (USCG analysis)

132. The KULLUK crew also noticed that the contingency emergency towline had become tangled in another line and would be difficult to retrieve. According to the Tow Master, another contingency emergency towline was then fashioned by connecting a 40 foot pennant wire from the starboard leg and two "lengths of 40 foot substantial line" found onboard the rig. The OIM was able to inflate a large buoy to connect to the end of the line configuration, which was all connected to the starboard leg pennant.

133. At 1150 hours a Coast Guard fixed wing C-130 aircraft arrived onscene to monitor the situation and assist in communication relay if necessary.

134. Between the hours of 1200 hrs and 1545 hrs on December 29, all 18 KULLUK crewmembers were hoisted from the helicopter deck by Coast Guard Helicopters CGR- 6010 and CG - 6044. Prior to the evacuation, a safety brief was held by the KULLUK crew. The crewmembers were taken off the KULLUK six persons in a departure group, all hoisted from the deck one at a time using a rescue basket. This was a challenging daytime operation and it was accomplished without incident. Prior to the evacuation the final 6 personnel secured the rig which included deployment of the contingency towline, securing the generator and closing sea valves. The survival anchor was also retrieved. The generators were left running to provide illumination on the rig. The final evacuation group included the Tow Master and the OIM.

135. Prior to completing the evacuation, the Tow Master radioed the AIVIQ and transferred command. The Tow Master shifted his responsibility to the AIVIQ Master at 1510 hrs according to the AIVIQ rough bridge log. The evacuated KULLUK crewmembers were taken to the Coast Guard Air Station in Kodiak leaving the KULLUK unmanned and under tow.

136. By 1330 hrs on December 29, all the AIVIQ's MDEs were back online. The AIVIQ engineering crew had replaced all inoperable injectors with the replacements delivered by Coast Guard helicopters.

137. At 1555 hrs on December 29, the NANUQ and the AIVIQ came into close quarters maneuvering situations and the vessels made contact on their side plating. The AIVIQ slacked the tow wire to avoid the towing hawser being entangled in the NANUQ's propellers. This situation occurred as the AIVIQ was shifting to a propulsion set up which put one MDE on each propeller shaft. This was a precautionary measure in the event of continued injector failure.

138. During this period with the KULLUK in tow of both the AIVIQ and NANUQ, progress was made to tow the KULLUK in a generally southerly direction, increasing distance from shore. The AIVIQ was on the port leg of the tow when looking forward from KULLUK out towards the towing vessels. At approximately midnight on December 29, the NANUQ and AIVIQ received direction from the Unified Command to head east and then north in an attempt to bring the KULLUK to a safe harbor, identified as Marmot Bay on the northeastern side of Kodiak Island. This would take them around the eastern end of Sitkalidak Island. As this maneuver was being conducted, the wind began shifting to the east, causing the KULLUK to begin to be set slowly to the west, despite the AIVIQ's and NANUQ's efforts. By 0600 hrs on the December 30, the wind had shifted again more from the south, allowing the KULLUK to make forward progress to the east. Throughout the tow, the NANUQ had difficulties while towing with the AIVIQ. The Captain stated that on several occasions his towing wire would "tight wire", indicating excessive loading of the towline. Seas and winds were also building as the towing operation continued.

139. Observed weather for this period is contained in the table below. As a strong low pressure system approached the area, the winds shifted from a more northerly/ northeasterly

direction to a southerly direction. Winds were extreme and seas were building into the morning of December 30.

Time	Wind	Seas
0700 29 Dec	30 – 40 S/SW	20 – 25
1300 29 Dec	25 NE	15 - 18
1900 29 Dec	40 – 50 NE	18 - 20
2300 29 Dec	40 – 50 NE	12 - 16
0300 30 Dec	40 – 45 E	15 - 20
1100 30 Dec	40 – 50 S	18 - 22

Figure 34: Weather data as recorded onboard the GUARDSMAN (USCG extracted and analysis)

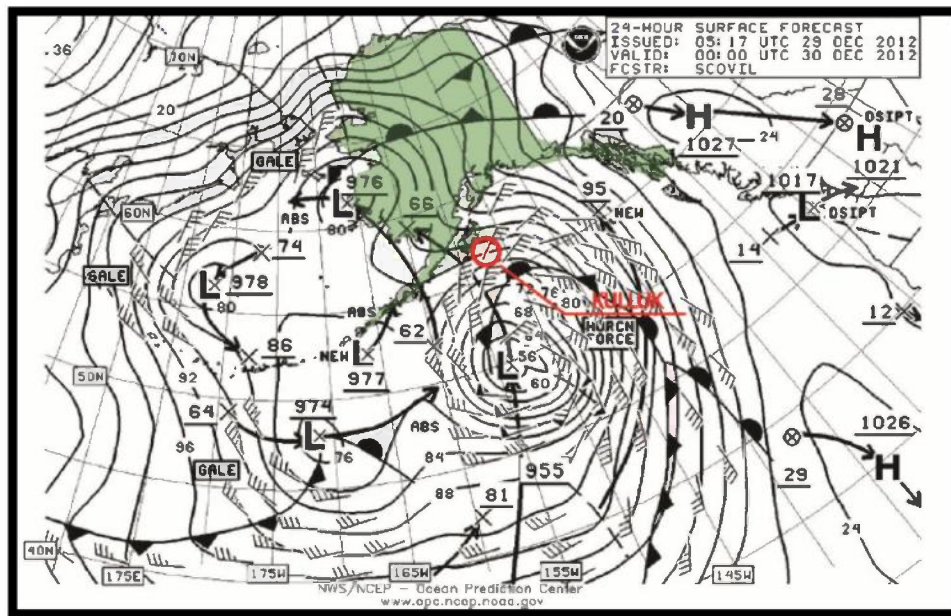
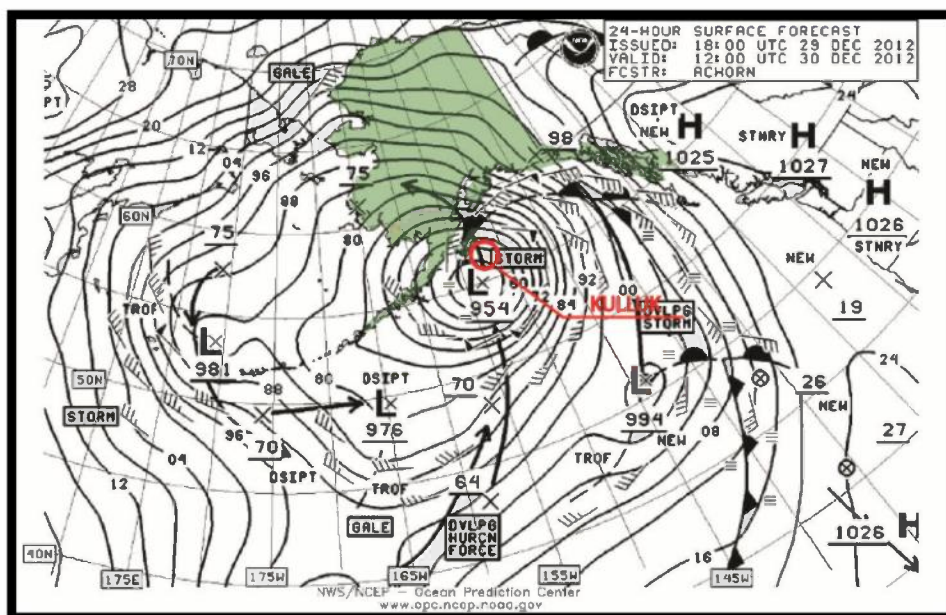


Figure 35: 24-hour NOAA surface forecast for 0000 hrs December 30, 2012. All times UTC. All times UTC (NOAA surface forecasts published on the internet and the Alaska portion of the map highlighted for clarity)



**Figure 36:** 24-hour NOAA surface forecast for 1200 hrs December 30, 2012. All times UTC (*NOAA surface forecasts published on the internet and the Alaska portion of the map highlighted for clarity*)

140. At approximately 1300 hrs on December 30, the NANUQ parted her wire tow hawser. Approximately 30 minutes later, the emergency towline from the AIVIQ parted as well. The emergency line parted at the eye near the thimble, on the AIVIQ side of the tow. The KULLUK was now adrift, the strong southerly wind causing it to drift and set toward the north/northeast.

141. Following the failure of the AIVIQ’s tow line, the decision was made to grapple the KULLUK’s #8 wire, which was trailing astern of the KULLUK deep into the sea following the failure of the NANUQ’s wire tow hawser. The AIVIQ was unable to safely rig up the vessel’s heavy and unwieldy grapple anchor, due to the rough sea state. The decision was made for the AIVIQ to transit to the closest area of protected water, along the northeast coast of Sitkinak Island. The AIVIQ departed the area at approximately 1915 hrs December 30 enroute Sitkinak Point. Once in a relatively protected area on the northeastern portion of the island, the AIVIQ used their crane to pick up their large grapple and deploy it safely to the deck. Once the grapple was rigged, the vessel once again returned to the KULLUK’s vicinity.

***Arrival of the ALERT***

142. At approximately 1325 hrs December 30, the ALERT arrived on-scene with the KULLUK and began to evaluate the situation. At 1600 hrs the ALERT positioned herself to the “stern” of the KULLUK in order to try and connect their tow package to the existing emergency towline from the KULLUK. The line was streaming in the water behind the vessel and there were other lines tangled in the tow line. The ALERT’s initial attempt was unsuccessful due to the weather and the tangled lines around the vicinity of the emergency tow line.

143. At approximately midnight on December 30, the GUARDSMAN’s starboard main engine clutch developed mechanical problems as the vessel was standing by on scene with the KULLUK. The vessel then departed the scene for the relative shelter of Sitkalidak Strait.



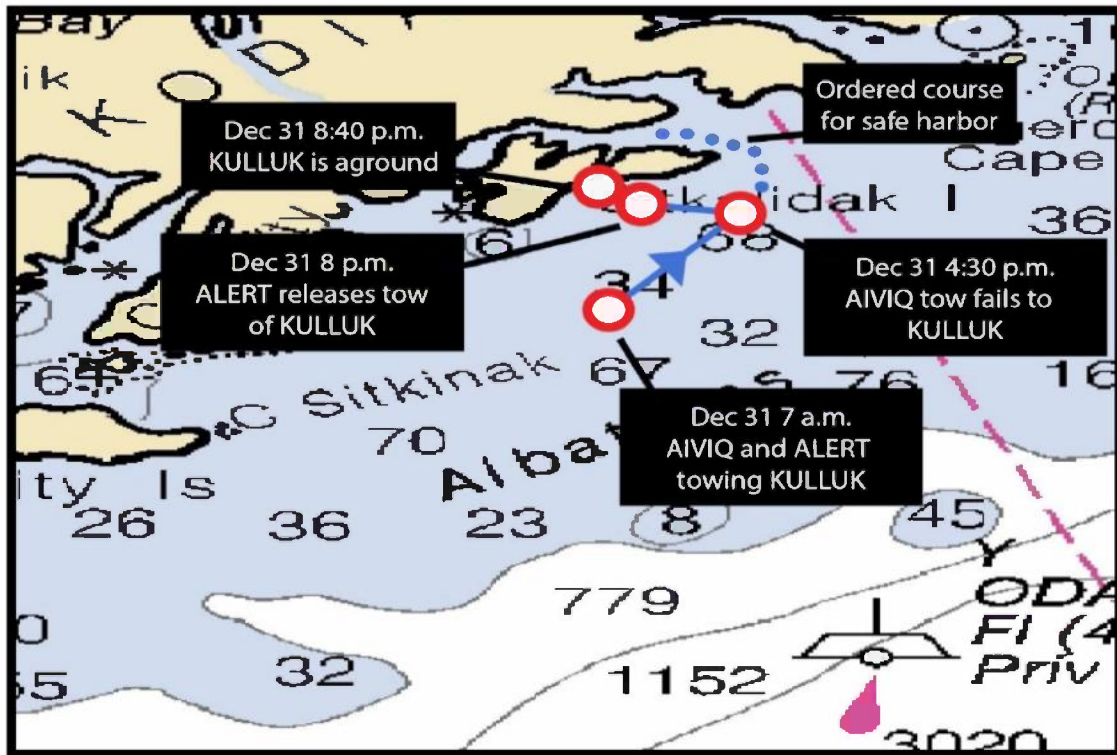


Figure 37: Diagram shows approximate locations of KULLUK between 0700 hrs AKST December 31 up to the grounding of the KULLUK. Significant events are highlighted. (USCG analysis)

144. At 0110 hrs December 31 the ALERT successfully retrieved the KULLUK’s emergency towline from the water. The ALERT deck crew pulled the chafed section of emergency tow line through far enough so they reached an undamaged section of tow line before making the knot. The thimble end had failed, so the ALERTs crew connected the two lines together using a bowline knot on the end of the emergency towline connected to a shackle on the ALERT tow gear. The ALERT was now towing with their tow wire, 250 feet of synthetic line, 250 feet of nylon grommet (shock absorbing line), and the 400 feet of emergency towing line originally attached to the KULLUK.

145. By 0400 hrs on December 31, the AIVIQ had returned to the scene rigged to retrieve the #8 mooring and NANUQ tow wire trailing deep into the water astern of the KULLUK. The AIVIQ utilized her grapple anchor, connected to the end of her tow wire which still contained the original 100 foot 3 inch pennant wire from the primary towing configuration. At approximately 0445 hrs the AIVIQ had successfully grappled the #8 wire and began hauling the bight of the wire onto the main deck of vessel. The AIVIQ was successfully able to grapple this wire hanging off the KULLUK in extreme conditions while the KULLUK was under tow from the ALERT. Upon inspection of the retrieved wire there was no evidence of the NANUQ’s parted wire tow hawser or the 150 ton shackle that was used to join the mooring wire to the #8 wire.

146. At approximately 0700 hrs on December 31, the AIVIQ successfully connected the recovered #8 wire to the AIVIQ's 3 inch pennant wire, which was connected to 90 feet of surge chain and the 3 ½ inch main towing wire of the vessel. The AIVIQ joined the ALERT in the tandem towing of the KULLUK with AIVIQ as the vessel in command of the operation.

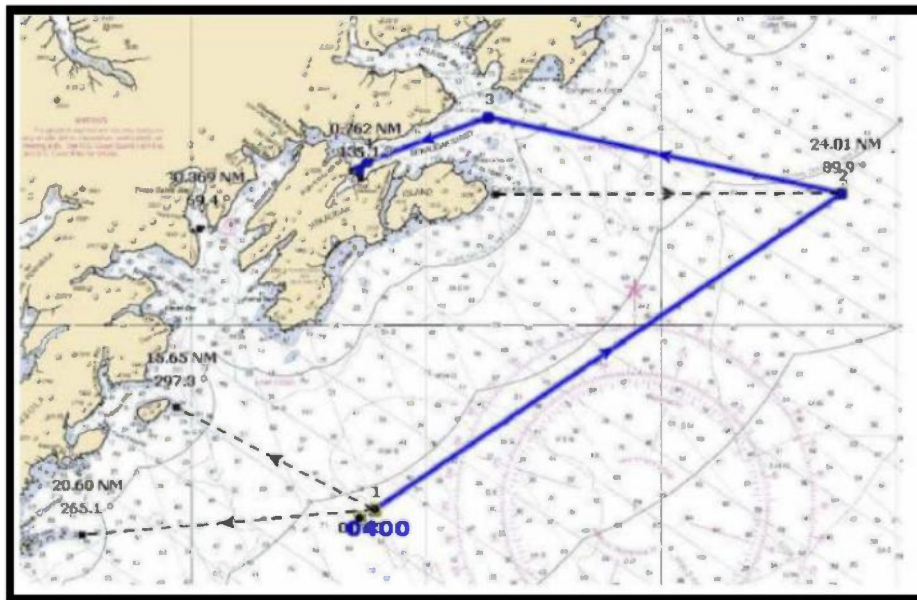


**Figure 38:** KULLUK under tow with the AIVIQ (left foreground) and the ALERT (right foreground) on December 31. (*USCG Photo*)

147. Following the establishment of towlines to the KULLUK by the ALERT and AIVIQ, the Unified Command made the decision to bring the KULLUK to a safe harbor. The location selected was Port Hobron, which is located on the northern side of Sitkalidak Island.<sup>83</sup> Port Hobron would provide good shelter from seas and winds from nearly any direction. From the 0400 position of the KULLUK, this would require a tow of approximately 74 miles.

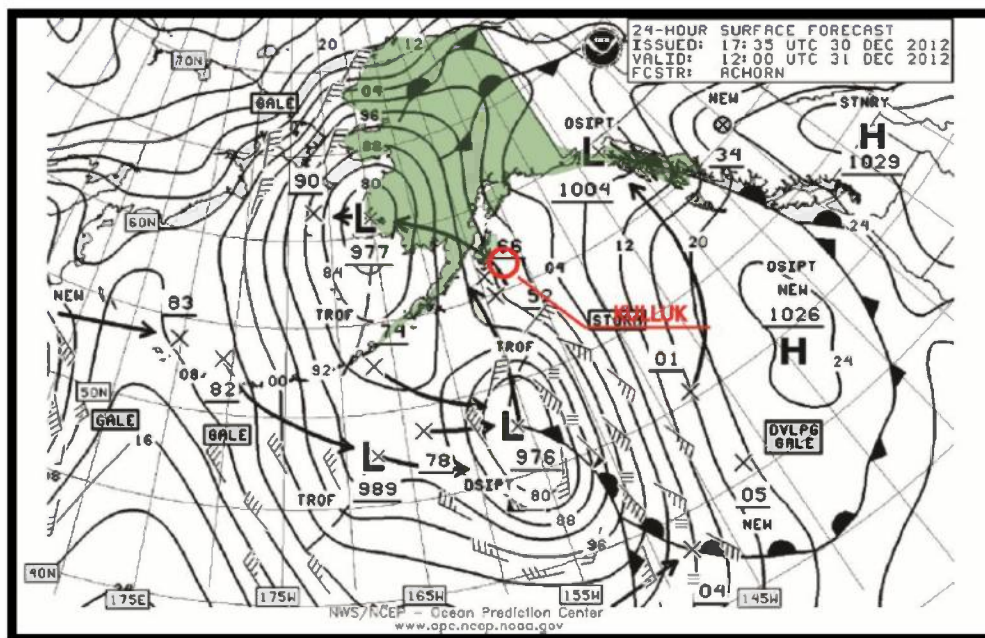
---

<sup>83</sup> Testimony of Mr. [REDACTED] formal hearing, transcript page 106.

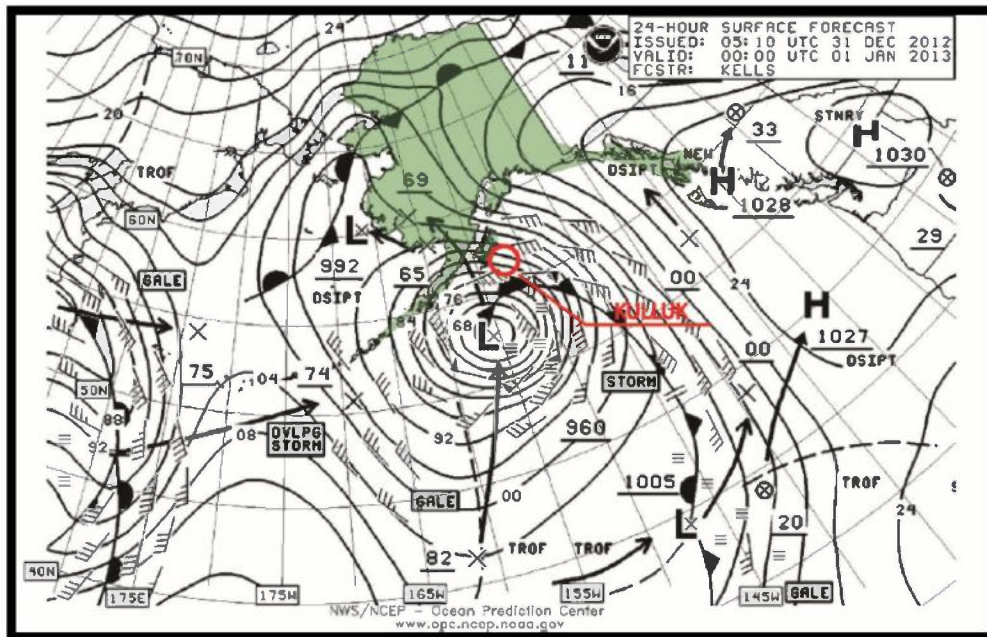


**Figure 39:** Tow route for the KULLUK for the destination of Port Hobron. (*Shell Tow Plan, CDU KULLUK Tow Procedure from Offshore Sitkinak Island Port Hobron PPOR*)

148. The AIVIQ and ALERT were able to tow the KULLUK between 3 to 4 knots until around 1100 hrs, when the towing speed was reduced as weather worsened as a strong low pressure front approached the location from the south. See figures 40 and 41.

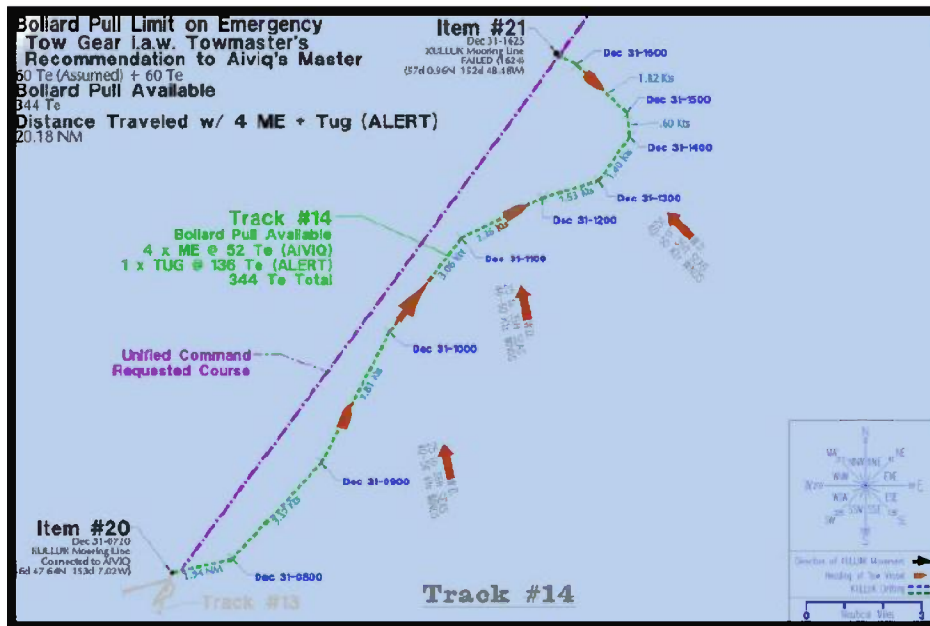


**Figure 40:** 24-hour NOAA surface forecast for 1200 hrs December 31, 2012. All times UTC (*NOAA surface forecasts published on the internet and the Alaska portion of the map highlighted for clarity*)



**Figure 41:** 24-hour NOAA surface forecast for 0000 hrs December 31, 2012. All times UTC. (NOAA surface forecasts published on the internet and the Alaska portion of the map highlighted for clarity)

149. Shortly after noon December 31 a Coast Guard helicopter hoisted four SMIT Salvage B.V. personnel aboard the KULLUK. They were to conduct a survey to determine the condition of towing equipment onboard the vessel. They were unable to conduct their survey due to the worsening weather conditions and extreme motion of the KULLUK. At 1336 Coast Guard helicopter 6003 hoisted these personnel off the KULLUK without incident.



**Figure 42:** Position of the vessels. The purple dashed line represents the course ordered by the Unified Command. (Chartlet provided by ECO for the Declaration on AIVIQ Bollard Pull, DECLARATION OF [REDACTED] WITH RESPECT TO THE GROUNDING OF THE DRILL RIG KULLUK, presented without editing)

150. At noon on December 31 the wind was 50+ knot from the east/ southeast with seas 15 feet and building.

151. According to the Master of the ALERT, on two occasions, between 1530 and 1600, December 31, the ALERT underwent extreme maneuvers to increase the distance between her and the AIVIQ, due to a concern they may collide while towing. At one point the ALERT Master sounded the general alarm to alert the crew to the impending danger. The vessels did not collide during these events.

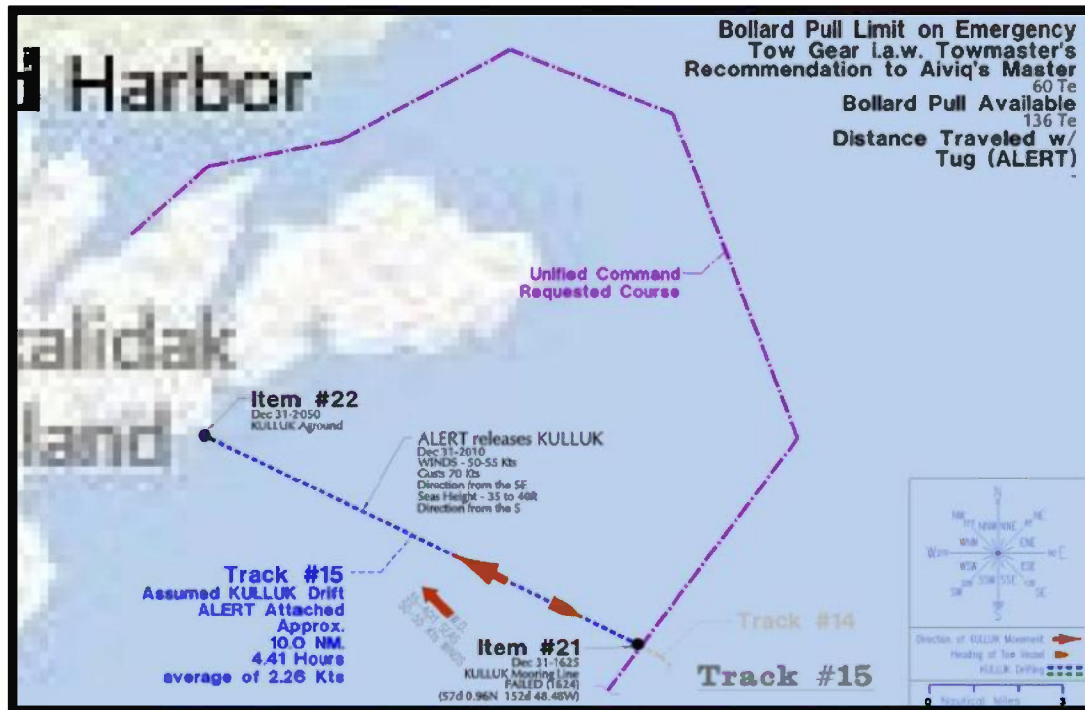
152. At approximately 1600 the ALERT and AIVIQ increased engine power in order to slow the continuing loss of ground and maintain a safe distance. The AIVIQ Master in communicating with ECO personnel ashore via email writes, "Both vessels will power up, no restrictions. Hope nothing breaks."

153. During this time period, the winds and seas increased and the KULLUK drift began to pull the AIVIQ and ALERT backwards, where neither vessel could make way against the seas with the KULLUK in tow. The KULLUK began to set or drift slowly to the northwest toward Sitkalidak Island.

154. At approximately 1630 December 31, the AIVIQ's tow pennant failed and the ALERT became the single vessel towing the KULLUK. The AIVIQ's 3 inch 100 foot pennant wire, the same wire that was part of the original towing configuration had parted. The ALERT was now towing the KULLUK alone in extreme weather conditions.

155. According to the AIVIQ's master, no other lines were available to tow the KULLUK. When the AIVIQ picked up the #8 wire earlier that day, they noticed that one of the secondary emergency lines that the crew of the KULLUK had rigged and deployed was tangled at the stern

of the KULLUK. In the prevailing sea conditions the AIVIQ would be unable to maneuver close enough to the KULLUK to attempt to pick up that secondary towing line. The AIVIQ moved into deeper water nearby as the seas increased and stood by the scene.



**Figure 43:** Position of the vessels. The purple dashed line represents the course ordered by the Unified Command. (Chartlet provided by ECO for the Declaration on AIVIQ Bollard Pull, *DECLARATION OF [REDACTED] WITH RESPECT TO THE GROUNDING OF THE DRILL RIG KULLUK*, presented without editing)

156. At approximately 1815, the Master of the ALERT became concerned that the tow would lose sea room, and ordered the engines to 100%. This increase in engine power did not significantly slow the progress of the KULLUK, now influenced by the high winds and seas, headed directly toward Sitkalidak Island. At approximately 1830, December 31. “Summary Shutdown Alarms” sounded on both engines. These alarms indicate that an engine performance parameter has been exceeded; they did not indicate that the engines are in the process of shutting down. Engine alarm logs indicated that these were due to high exhaust manifold temperatures. As a result of these alarms, the ALERT quickly reduced power back to 85% on both engines to bring the exhaust manifold temperature out of the alarm state.

157. The ALERT, under the direction of the UC, now tried maneuver against wind and sea to influence the ultimate grounding location of the KULLUK onto the shelving beach of Oceans Bay, Alaska. Influenced by the strong winds and seas, the ALERT was towing the KULLUK head to the seas and wind but losing ground towards the shore.

158. At 1930 the AIVIQ departed the KULLUK vicinity for protected waters near Sitkinak Point.

159. With the KULLUK now only approximately 3 miles from grounding on Sitkalidak Island, the Unified Command decided that the ALERT should cut the KULLUK lose. The decision was made primarily to ensure the safety of the ALERT and her crew. At approximately

2000 on December 31, the ALERT was instructed to release the tow of the KULLUK. Ten minutes later, the tow was released by spooling the towline off of the main winch drum.

160. At 2015 December 31, the ALERT headed to the more protected waters located in Sitkalidak Strait. The KULLUK was adrift with the winds and seas pushing the unmanned rig toward the beach at Oceans Bay.

161. At approximately 2040 December 31st, 2012, the KULLUK ran aground on the eastern coast of Sitkalidak Island, in Oceans bay in approximate at 57. 05.4 N, 153 061W.

162. At the time of the grounding the KULLUK there were approximately 143,000 gallons of ultra-low sulfur diesel, 1,000 gallons of aviation fuel and roughly 12,000 gallons of other petroleum products on board the KULLUK. There is no evidence that any oil spilled for the KULLUK. Small amounts of oil were released from the grounded survival capsules which were ripped free from the KULLUK by the pounding seas during the grounding.

163. The KULLUK remained grounded until 2200 on January 6, 2013 when towing vessels were able to refloat and tow the KULLUK to Kiliuda Bay, Kodiak Island, as part of the salvage plan.



Figure 44: KULLUK grounded in Oceans Bay, Alaska. (USCG Photo)

164. As a result of the grounding the KULLUK sustained extensive damage. Topside and underwater inspections were conducted prior to refloating the vessel. The underwater portions of the hull sustained extensive damage due to the grounding and the action of the wave surge effects. Despite this exposure the hull retained watertight integrity. Topside damage to the rig included damage to the actual superstructure and accommodations including damaged railings, ladders, fittings, watertight doors, windows and the adjacent interior spaces. Electrical equipment

such as switchboards, distribution panels and other electrical equipment were exposed to wind driven water and immersion in seawater rendering this exposed equipment questionable for future use. Primary lifesaving equipment was torn off the rig by wave action resulting in the loss or damage to of all life rafts and most life rings. The embarkation ladders, personal flotation devices and immersion suits and firefighting equipment were also damaged. There was down flooding of seawater into numerous interior spaces including engineering spaces. The additional weight of the seawater retained aboard caused an increase in draft for the eventual move back to Dutch Harbor from Kiliuda Bay.



**Figure 45:** Composite photographs showing damage to topside areas of the KULLUK taken by USCG Inspectors after the grounding and prior to refloating. (*USCG Photos*)



## ANALYSIS

### Existing Authorities and Standards:

1. During the course of this investigation, a search for existing standards that apply to towing operations<sup>84</sup> of this type identified the following:

#### International

- a. The International Maritime Organization (IMO) published MSC Circular 884 on December 21, 1998, titled *Guidelines for Safe Ocean Towing*. “The objectives of these Guidelines are to ensure safety at sea, prevention of human injury or loss of life, avoidance of damage to the environment, in particular to the marine environment, and to property through providing minimum recommendations for the organization, planning and execution of ocean towages and the design of associated equipment”. These guidelines discuss tow planning, manning, surveys, design environmental conditions, and towing equipment. Guidelines of this type are recommended practices for incorporation into flag state rules and requirements, and have not been officially adopted by the United States or Republic of the Marshall Islands.

#### Federal

- b. 33 Code of Federal Regulations Part 164 contains provisions for those vessels engaged in towing. 33 CFR Part 164.74 contains general provisions for determining the adequacy of towline strength, adequacy and recordkeeping. 33 CFR Part 164.78 contains provisions for navigation for those vessels towing. These provisions are general in nature, and with the exception of testing criteria for towlines themselves, does not provide specific guidance with respect to sizing of towing gear nor does it reference any established standards or guidelines.
- c. The U.S. Coast Guard does not have any statutory or regulatory requirement to review or approve towing operations of this nature. While there is no requirement, several Coast Guard COTPs<sup>85</sup> have required additional oversight of vessels requiring tows, typically those vessels experiencing propulsion or steering failures. This authority is derived from 33 CFR Part 160.111 (c) and 33 CFR 160.215. Under these provisions, the Coast Guard may require additional safety precautions, such as a verification of the vessel’s seaworthiness, pollution potential, and the adequacy of the towing arrangement utilized. No such standing policy existed within the Coast Guard COTP Western Alaska structure for MODU movements.

#### State and Local

- d. This investigation did not find any applicable regulations for the State of Alaska that focused on MODU towing safety.

#### Industry

- e. Vessel insurance companies often require that a warranty survey be conducted prior to certain operations, including the towing of MODUs. Warranty survey providers are third-party companies that conduct an independent review of the towing operation. Most warranty survey companies have developed guidelines for towing operations of all kinds, including the

---

<sup>84</sup> Towing operations includes those specific regulations, policies or guidance that addresses safety considerations for those vessels being towed or those vessels towing only.

<sup>85</sup> Captain of the Port (COTP) is defined at 33 CFR Part 1.01-30.

movement of Mobile Offshore Drilling Units (MODUs) from one location to another. Two such warranty surveyor providers include GL Noble Denton and MatthewsDaniel, both which conducted surveys for the MODU KULLUK.

- f. Classification societies generally inspect and approve towing gear that is considered a part of the vessel, such as Smit Brackets (MODUs), winches and shark jaws (Towing Vessels). Towing wires, shackles, towing plates and other such equipment that makes up a towing configuration is generally not inspected or approved.
  - g. Additionally, many towing companies have developed procedures and guidelines that address the safe movement of vessels under tow. Several differing industry standards exist.
2. In the absence of a regulatory regime and enforceable standards, the responsibility to manage MODU towing risks falls primarily with the towed/ towing vessel owner and operator.

**Operational Risk Management:**

**Unique Features of the KULLUK**

3. The KULLUK’s hull is conical in design, with no distinctive bow or stern. The design of the vessel exposes a broad expanse of the hull to hydrodynamic effects of the sea, including the effects of current and swells/ wind driven seas. The derrick, cranes, accommodation and control spaces result in significant sail area or the effects of wind on the vessel. The severe outward slope of the hull below the chine increases overall hull resistance to the seas when the vessel is pitching, rolling or heaving in heavier weather.



**Figure 46:** The KULLUK out of the water and loaded on the deck of a heavy lift ship. (USCG photo)

4. Tow resistance calculations and studies describe the significant bollard pull requirements necessary to successfully tow the KULLUK. These are further discussed in the “Tow Resistance and Bollard Pull” section below. Additionally, first-hand accounts of Mr. [REDACTED] who

served as Tow Master of the KULLUK over several previous voyages, are contained in the table below.<sup>86</sup>

Sea State/ wind	Sea Direction	Result
6 Meters (18 feet) and below		Waves tend to slap vessel, resulting in minor accelerations under tow
7 Meters and over		Can experience rapid accelerations in any direction
	Seas from abaft of beam to 60 degrees	Increased rolling motion and “slamming” that result in accelerations and slow tow
	60 degrees to dead on bow	Greater rolling motion and “slamming”, resulting in considerable changes in acceleration
10 Meter Seas (~33 feet)		Pitching over 20 degrees which can result in violent synchronous pitching motion. It can then “slingshot” forward, resulting in rapid accelerations and stopping once the hull becomes buried in seas
Wind		In higher winds, the KULLUK would act like “balloon on a string”, and would not follow behind the towing vessel well in wind from the beam.

**Figure 47:** General Towing and Motion Characteristics of the KULLUK from first-hand accounts of KULLUK Tow Master (*USCG Analysis*)

5. Pitching, rolling and heaving all have negative impacts with respect to the overall towing resistance of the vessel. Excessive motions, particularly pitching and heaving motions that can expose a vast expanse of the hull to hydrodynamic resistances of the water and seas create motions of the vessel that make it difficult for towing vessels to maintain constant towline tension. Severe pitching is evident in the figures below.

6. Additionally, the KULLUK’s main towing bridle is uniquely configured; as the Smit brackets to which the bridle is connected are so close together that they almost act as a single line. The result of this configuration produces less resistance and correction of rotational movements of the vessel at sea, particularly due to the conical design, potentially contributing to extreme tensions acting on towing lines and accessories.



**Figure 48:** Screen captures showing extreme pitching resulting in the KULLUK burying hull into seaway and causing increased towing resistance. (Taken from YouTube video taken by unknown AIVIQ crewmember during afternoon hours of 31 December with AIVIQ and ALERT towing, video titled “KULLUK rescue 2012 Gulf of Alaska”)

<sup>86</sup> Testimony of Mr. [REDACTED] ORMI, on 16 July 2012



Figure 49: Photo of towing bridle connections to Smit Brackets (USCG Photo)

**Gulf of Alaska Weather**

7. Weather patterns in the Gulf of Alaska are notoriously treacherous to mariners, particularly during the winter months. *The United States Coast Pilot 9, Pacific and Arctic Coasts Alaska: Cape Spencer to Beaufort Sea*, contains the following description for the winter period (October to March) in the Gulf of Alaska:

“The Aleutian Low looms over the North Pacific as a climatic warning to mariners navigating the Alaskan waters. This semi-permanent feature is made up of the day-to-day storms that traverse these seas in a seemingly endless procession. With these storms come the rain, sleet, snow, the howling winds, and the mountainous seas that make the northern Gulf of Alaska and the southern Bering Sea among the most treacherous winter waters in the Northern Hemisphere. In the northern and western Gulf of Alaska and in Bristol Bay, sustained winds may reach 60 to 70 knots; significant wave heights can climb to 30 to 40 feet (9.1 to 12.2 m), with an extreme wave height of 60 to 75 feet (18.3 to 22.9 m). These extremes are most likely to occur during the winter season.”

8. Additional information as provided by the Shell contracted study entitled *METOCEAN Design Criteria for Tows to/from Dutch Harbor, Alaska; and Bellingham, Washington* validates the Coast Pilot information, indicating a substantial increase in both expected wind and seas

from October through March. At the 10% exceedance level<sup>87</sup>, any tows can expect seas as high as 9.2 Meters and 44.6 knot winds for December tows. Values at the 10% exceedance level are likely to occur on an average for 10% of the time on every voyage.

9. The investigation has revealed that the tow planners did not recognize the risks, nor adequately plan for a towing evolution of such a unique vessel during the height of winter in the Gulf of Alaska. No reassessment of Bollard Pull requirements or towing configuration was conducted prior to the KULLUK departing Dutch Harbor in December of 2012. Additionally, the warranty survey, as conducted by a GL Noble Denton warranty surveyor did not conduct an assessment of the towing equipment configuration prior to the tow. Coast Guard Sector Anchorage was aware of the towing operation but did not conduct a review or assessment as this is not a requirement or standard practice by regulation or existing policy.

### **Contingency Planning**

10. Shell created a Towing Plan for the voyage, which contained actions to take during a number of contingencies that may be encountered during the tow of the KULLUK. This plan addressed individual contingencies, and did not account for multiple and compounding events. An example of this compounding of events would be the failure of the towing equipment followed by a failure of vessel propulsion.

### **Loss of Tow**

11. In the eventuality of towline failure, there were two options available to mitigate this threat. First was the availability of an Orville Hook onboard the AIVIQ. The hook is designed primarily to capture chain as it is towed astern by the towing vessel attempting recovery, allowing the towing vessel to seize the chain connected to the remains of the main towline and reestablish tow. There are two notable drawbacks to this approach considering the location of the towline failure and the heavy weather being experienced at the time.

- a. The towing vessel would have tow the Orville Hook into close proximity of the KULLUK, attempting to snag the towing bridle, which only consisted of 90 feet lengths of chain.
- b. Once retrieved, the AIVIQ would be required to bring the bridle onto her deck to reconnect the tow. This would require the vessel to maneuver and maintain position within extremely close proximity to the KULLUK in high seas. .

12. The second option offered is the use of the emergency towing line. This synthetic line, purchased in mid-2012 would offer some shock absorbing capabilities as well as sufficient strength, possessing a minimum breaking load of over 400 tons. When deployed, the 400 foot length of the line and float at the terminus end would allow the AIVIQ to achieve safe connections while maintaining a safe distance from the KULLUK. Once established, the plan called for the tow being taken to a safe harbor.

### **Towing Vessel Breakdown**

13. The breakdown of the towing vessel, either electrical or mechanical, is perhaps the single most hazardous event that can take place on a tow. Such an event places both the towed and towing vessel in danger. While this eventually is listed as a contingency under the plan, no

---

<sup>87</sup> The study provides wind and wave encounter statistics along three possible routes from Dutch Harbor to Bellingham. The results compiled include 30 years of historical voyage data along the routes examined.

mitigation measures are address with the exception of “make an alteration of course away from the KULLUK. Once risk of collision passes, the vessels will assess and then stabilize the situation as required.”<sup>88</sup> An assumption is made that the towing vessel will be able to effect repairs in a timely fashion, without outside intervention, and the tow will remain in good water during that time. It does not foresee the type of catastrophic propulsion failures that the AIVIQ experienced during the tow.

14. From the risk assessment provided to the investigation, titled May 12 Logistics Marine HAZID (Hazard Identification) table, the “selection of a coastal route, availability of the AIVIQ’s redundant systems and availability of spare parts” played a role in the planner’s mitigation strategy. Other mitigation strategies for this contingency, including the use of dual towing vessels or the availability of capable assist vessels, either located along the vessel’s route or as an escort were not addressed in this contingency document or planning.

### **Survival Anchor**

15. The use of the survival anchor was not addressed in the tow plan. The survival anchor and the associated windlass, engine and ground tackle appear to be fully functional as designed. The tow plan does discuss the addition of five anchors and the existing twelve anchor/mooring wires aboard the KULLUK. This is discussed in the context of mooring or anchoring operations when the KULLUK arrived in the Seattle area. These anchors were not ready for use or used in the emergency situation, and would have required the use of the KULLUK’s onboard cranes to rig and deploy.

16. During the voyage, the survival anchor was utilized in an effort to either stop the KULLUK, change the angle of the vessel to the wind or slow her progression toward land. The effect of the anchor on the movement of the KULLUK cannot be adequately determined due to conflicting accounts of the use of the anchor and the forces acting on the KULLUK, including the towing vessels. The KULLUK Operations Manual makes a brief mention of the use of the survival anchor if water depth permits in section 3.1.20 it states “If the water depth permits, be prepared to drop the survival anchor if the tugs cannot control the KULLUK.”

17. The evacuation of the crew of the KULLUK on December 29 removed the option of deploying the anchor later in the incident. When the crew was evacuated the KULLUK was under tow and the use of the anchor at that time was not considered an option. The option to deploy the anchor was available at the time the SMIT team visited the KULLUK on December 31. At the time the KULLUK was under tow by both the KULLUK and ALERT and use of the anchor was not considered.

### **Single Towing Vessel**

18. The KULLUK had been towed by the single towing vessel AIVIQ on three previous occasions in 2012, participating in all tows of the KULLUK since her construction in 2012 and charter by Shell. The use of a single towing vessel introduced risks into the operation.

19. The use of a single towing vessel with single main towline sets up a single point of failure system. When a single component fails, the towing vessel must attempt to re-establish tow on the main system, or utilize a contingency emergency towline. It should be considered that when an emergency towline is used then an emergency situation has been created. The use of a single towing vessel also introduces risks should the towing vessel experience mechanical

---

<sup>88</sup> Section 8.4 of the KULLUK Towing Plan.

difficulties, including the loss of propulsion. This leaves both vessels unable to maneuver and at the mercy of the prevailing wind, seas and currents.

20. The use of multiple tows mitigates negative consequences in the event of a single towline failure or vessel breakdown. In each event, the towed vessel can still be maneuvered and towed utilizing the main towing system. The single towing vessel exerting some measure of control until the towline for the other vessel is reestablished or the other vessel returns to fully operational status or another towing vessel arrives at the tow location. The use of multiple tugs to tow a single object can pose complications in a tow. There is the danger of the tugs fouling each other's tows and towing equipment. The size and power of the tugs must be complimentary to allow a consistent and equal division of power and tension between the towed object and the towing vessels.

21. In February 2013 Shell Oil Company towed KULLUK from Kiliuda Bay, Kodiak, Alaska, to Dutch Harbor using a three-vessel tow. The AIVIQ was not used for this tow. In the case of the February tow, three tow vessels were needed in order to provide the proper bollard pull. In addition, the February tow plan contained more detailed contingency plans than the December tow plan in the event of tow gear failure. It would be too simplistic to state categorically that the success of the February tow shows that a multiple-vessel tow should have been used in December. The February tow does show, however, that despite evidence and testimony that multiple-vessel tows are inherently hazardous, multiple-vessel tows of vessels such as KULLUK can be completed safely. Multiple-vessel tows, or at least single-vessel tows with escort vessels, mitigate the risk of unescorted single-vessel tows by providing either a second set of tow gear or an on-scene contingency response vessel.<sup>89</sup>

### **Weather Routing**

22. The tow route that was selected for the December 2012 towing operation comprised a voyage of 1773 nautical miles. Shell commissioned a weather study, which produced a document titled *METOCEAN Design Criteria for Tows to/from Dutch Harbor, Alaska; and Bellingham, Washington*. This product was generated by Jeppesen's TOWSIM using OceanWeather, Inc.'s 30-year global wind and wave hindcast database for various towing routes under consideration. This study focused on the predictable weather for three different routes across the Gulf of Alaska using historic weather observations. The three routes considered were the Coastal, Great Circle and Rhumb Line. The Executive Summary for the METOCEAN Report states:

“Taking the coastal route normally will experience less severe weather as the storm dissipates towards the coast. However the tow duration will be lengthened by two extra days at 4.5 knots speed. Overall, the criteria based on lowest of the three routes are not significantly different from the individual routes. This indicates the effect of weather routing is minimal due to the wide spread of the severe weather in the Gulf of Alaska and the slow tow speed of the rig.”

23. Both the Great Circle Route and Rhumb Line routes offered a shorter transit time when compared to the northerly/ coastal route and would put the tow in deeper water for the majority of the transit, allowing for more flexibility for the towing vessel to deploy longer towing lines. It would also have the drawback of experiencing slightly higher seas and wind.

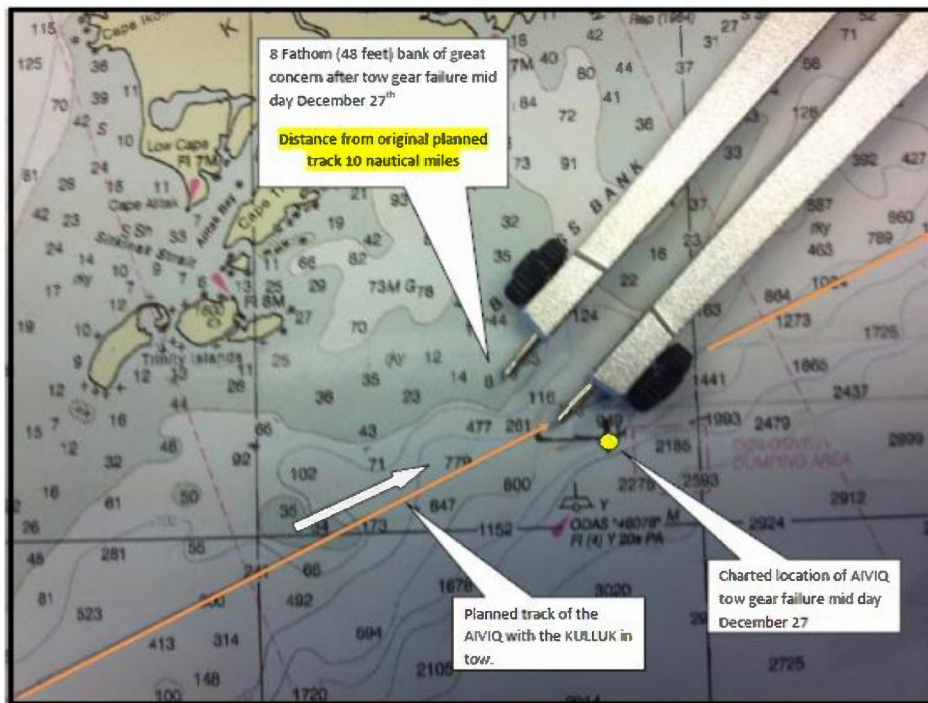
---

<sup>89</sup> Operations Procedure KULLUK Tow Plan: Kiliuda Bay, Kodiak Island Alaska to Captains Bay, Unalaska, dated 2/11/2013.

24. To address weather concerns, Shell contracted with Impact Weather to provide daily route specific weather forecasts for the duration of the KULLUK tow. The KULLUK Tow Master and AIVIQ Captain utilized these, along with other sources of weather forecasting during the transit.

25. In hindsight, this route's proximity to shoal water and land masses proved to be a critical factor in the towing and response operations. At the time of the shackle failure, the KULLUK was approximately 40 miles from the closest point of the islands of Kodiak Island and less than 10 miles from Albatross Bank. The loss of the AIVIQ's engines and extreme weather moved the KULLUK north toward these hazards. This planned route denied the proper sea room necessary should a towline fail or the towing vessel experience a mechanical breakdown, particularly with no assistance or additional towing vessels onsite. Additionally, should the tow need to heave to in the event of a weather event, there was little safe water available to ride out storms.

26. The AIVIQ did make a turn to the east during the morning hours of December 27 in an effort to lessen the time the tow would be subject to severe weather. The results of this course change are evident as the tow was south and east of the planned route.



**Figure 50:** Chart showing planned track line for towing of KULLUK demonstrating close approaches to land and other hazards. (USCG Developed)

**Tow Resistance and Bollard Pull**

27. Tow resistance studies determine total tow resistance expected in different sea/ wind states and forward speeds of a vessel through the water. Such studies are important as they



determine how much towing force, or bollard pull,<sup>90</sup> towing vessel(s) must possess to successfully tow the vessel. In the case of KULLUK, the investigation identified three studies that were applied to the KULLUK to determine towing resistance in different wind and sea states. The first was an open water model test conducted in 1982.<sup>91</sup> The second was an engineering study conducted in 2010. The third was also an engineering study conducted in January of 2013 following the KULLUK grounding; naval engineers involved in this study based their analysis on the results of the open water model test.<sup>92</sup>

28. According to the study conducted in 2010, “The generally accepted minimum criteria for holding position in a storm is a significant wave height of 5m and a wind velocity of 40 knots, which corresponds approximately to a Beaufort 8 sea state, with a head current velocity of 1 knot. Less stringent criteria can be used if the tow will be accomplished within a weather window that can be confidently forecast.” The study determined that 170 tons of bollard pull would be necessary to meet this criteria. A review of towing guidance created by the IMO, MatthewsDaniel and GL Noble Denton indicate that they utilize similar minimum criteria for towing operations. According to testimony by Mr. ██████████ Shell Alaska Marine Manger, the total bollard pull necessary to successfully tow the KULLUK for all 2012 towing evolutions was determined to be 200 tons, based upon the 2010 study. This corresponds to a Beaufort 9 storm with a wave height of 7m and a wind velocity of 47 knots, with no current.<sup>93</sup>

29. The AIVIQ completed a bollard pull test in June 2012, and it was determined that the vessel possessed a bollard pull of 208 tons, in accordance to the bollard pull certificate issued by ABS. This bollard pull places the AIVIQ among the most capable vessels with respect to towing capabilities in the industry.

	Wave	Wind
2010 Study expectations	5 meters	40 knots
December 2012 Metocean using 10% exceedance level <sup>94</sup>	9.2 meters	44.6 knots
Difference	4.2 meters	4.6 knots

**Figure 51:** Comparison of weather conditions used to determine bollard pull requirements. (*USCG Analysis*)

30. The Metocean study conducted for the December 21, 2012 tow of the KULLUK contained wind and wave statistics that, even at the least conservative 10% exceedance rate, were significantly higher than the wind and wave criteria established for the bollard pull requirements in the 2010 study conducted for the KULLUK. There is no indication that the bollard pull calculations for the KULLUK took into account the expected/ anticipated weather for the 2012 tow from Dutch Harbor to Seattle that was contained in the Metocean study. Instead the tow planners relied on calculations completed for a 2010 tow to Dutch Harbor from McKinley Bay, Canada, that occurred during the summer months. When asked whether the bollard pull requirements were reassessed prior to the December 2012 tow, to address the sea state predicted in the Metocean study, Mr. ██████████ stated that based on the experiences towing the KULLUK, he had no concerns with the capability of the AIVIQ to conduct a single tow. For all of the 2012

<sup>90</sup> “The maximum force a tug can exert on the towline is defined as the tug’s maximum propulsion power delivered a zero tug speed”, U.S. Navy Towing Manual, page 3-24.

<sup>91</sup> Open Water Model Tests Final Report for Conical Drilling Unit for the Beaufort Sea, 4/1982.

<sup>92</sup> Rig KULLUK Tow Away Tow Resistance Calculations, Jensen Naval Architects & Marine Engineers, 1/24/2013.

<sup>93</sup> Id.

<sup>94</sup> Data taken from Coastal Route tables.

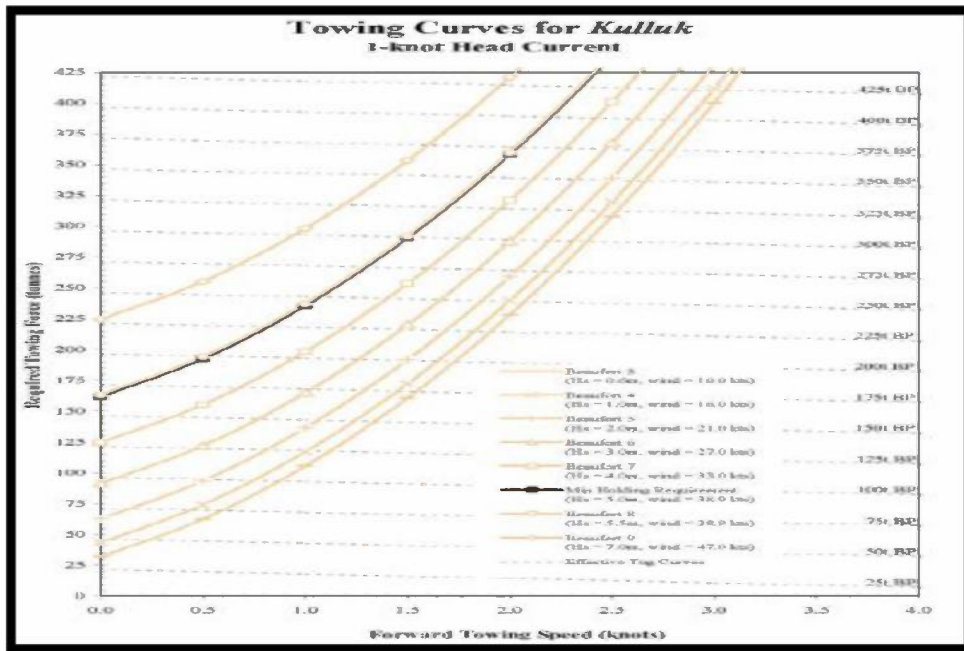
tows of the KULLUK by the AIVIQ, the tow planners determined that the AIVIQ provided sufficient bollard pull for the tow.

31. The 2010 study contains towing resistance curves for Beaufort 3 through 9 weather conditions. The 10% exceedance level for the December 2012 tow indicates 9.2 meter seas and 44.6 knot winds. These weather conditions are similar to Beaufort 9 storm conditions, being 2.2 meters above Beaufort 9 seas and 2.4 knots below Beaufort 9 winds. Referencing figure 52, extracted from the study, the bollard pull necessary to maintain position in a 1 knot current would require 225 tons of effective bollard pull by the towing vessel. Referencing the same document, a 200 ton effective bollard pull would be necessary under the same circumstances with no current. It should be noted that the prevailing currents along the southern coast of Alaska are out of the east, meaning that the KULLUK would most likely be towed into the current.

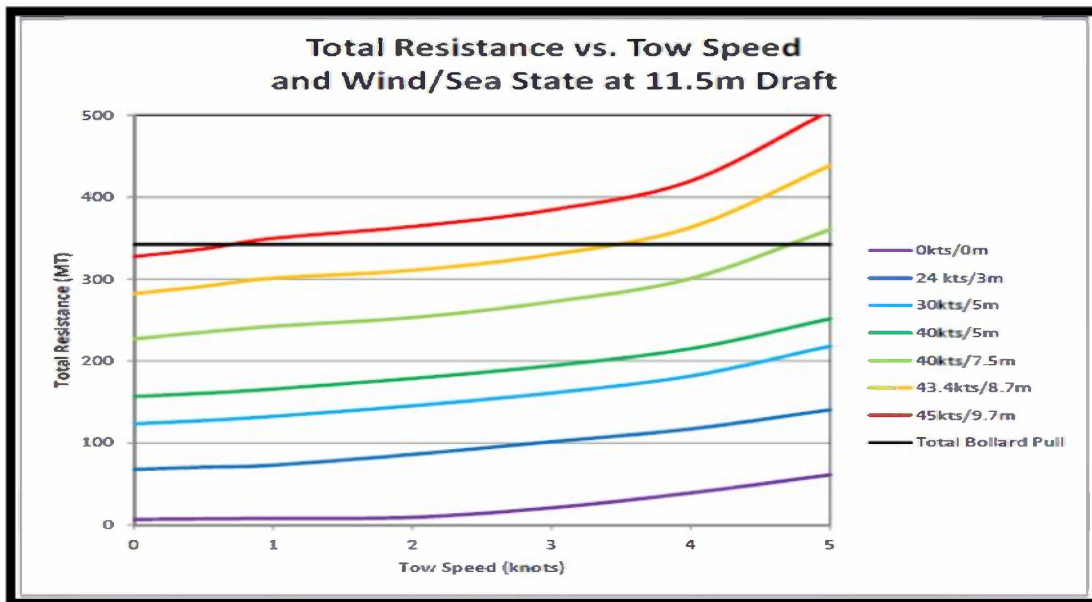
32. After analyzing the data, the AIVIQ would be capable of generally maintaining position with the KULLUK in tow during Beaufort 8 weather in 5 meter seas and 40 knot winds while encountering a 1 knot current, with all forces acting against the tow into the wind and seas. In weather conditions in excess of this standard, as predicted by the Metocean study, the AIVIQ could not be expected to maintain position, and would be pulled astern by the forces acting on the KULLUK. In the Alaskan maritime environment towing operations that are experiencing poor weather do at times allow themselves to be pulled astern until the weather subsides. These tow planners build sea room into the planning to allow for the weather. In the case of the KULLUK towing operation for December 2012, this would be an unacceptable risk considering the length of tow, the near shore routing, and the fact that, as the Metocean data suggests, this weather may occur over 10% of the tow transit.

33. Tow planners for the February 2013 KULLUK tow based the bollard pull requirements of the MODU on weather exceedance levels as provided in Metocean studies for the proposed route in order to ensure the tow would not encounter winds or seas that may threaten to overwhelm the bollard pull of the towing vessels involved. As a part of the planning process, a new tow resistance study was conducted for the KULLUK, yielding higher initial tow resistances for the vessel, due primarily to a slight increase in draft (11.5m vs. 9.5m) and basing their report on open water test results from a study conducted in 1983. For this tow, planners wanted to ensure sufficient bollard pull was available for tow resistances anticipated during a weather event equivalent to that anticipated at the 10% exceedance level in accordance with the Metocean study conducted for that route and month. As a result, the criteria by which the planners determined the necessary bollard pull for the tow included what was necessary to maintain position in 43.7 knot winds and 8.7 meter seas. The result was a bollard pull requirement for the KULLUK of 282 metric tons. To maintain some "overhead" for this bollard pull requirement, three vessels were chosen to tow the KULLUK, totaling over 350 tons of bollard pull.

34. Given the Gulf of Alaska weather patterns, the practice of relating bollard pull requirements with anticipated weather, particularly for longer voyages where weather cannot be accurately predicted, is prudent for longer duration voyages. The application of additional bollard pull capabilities, among additional towing vessels also provides a level of redundancy in the event of tow gear or mechanical failures. In addition to these benefits, multiple vessels allow a "sharing" of towing gear loads, where in a worst case weather scenario, no vessel would be required to exert their full bollard pull capabilities to maintain control of the tow, reducing the stress on towing equipment utilized.



**Figure 52:** Towing Curves (Tow Resistance) for the KULLUK with 1 knot head current as provided by Global Maritime 7/6/10 (Provided by Shell, Shell Alaska "Bollard pull calculations for Towing KULLUK from McKinley Bay to OSI South Reef Dock, Captains Bay, Unalaska Island, Aleutian Islands" GMH-6565-2575)



**Figure 53:** Tow resistances for KULLUK as determined by Jensen Marine Architects and Marine Engineers, 1/24/13 (Provided by Shell, Jensen Report 130003-245-1, rev. A)

**Towing Configuration**

35. This investigation has revealed that there are numerous industry standards exist for determining the adequacy of this type of towing operation.

36. Specific Federal Regulations do not exist for determining the adequacy of this type of towing operation. Regulations contained in 33 CFR Part 164 are general in nature and allow flexibility in determining towing components. For shackles and other connecting gear, the owner, operator or master of each vessel towing astern shall ensure that the material and size are appropriate for the strength and anticipated loading for the environment. It does not provide any additional guidance with respect to how that determination is made.

37. In the case of the KULLUK, the towing gear was developed prior to the KULLUK's 2012 drilling season by a number of experienced personnel, including a Shell employee who had considerable rig moving experience, Noble Drilling, Edison Chouest, an experienced Tow Master; with the overall arrangement found acceptable to a warranty surveyor. In the case of the KULLUK's December 2012 departure from Dutch Harbor, the towing arrangement was not assessed or redesigned to account for the anticipated weather along the route. In testimony, the Shell Marine Manager "had no doubt with respect to adequacy of the tow, or towing arrangements." The GL Noble Denton warranty surveyor did not conduct an assessment of the towing configuration to ensure it met guidance provided in his companies' policies. According to the contract between Shell and GL Noble Denton, GL Noble Denton was hired to "provide warranty survey and certificate of approval for the tow."

## **Shackle Failure on December 27, 2012**

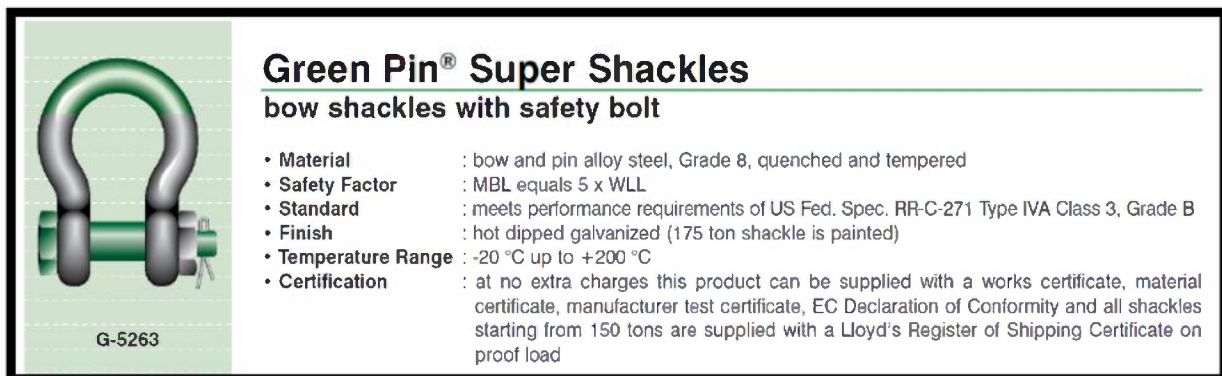
### **History and Usage**

38. The apex shackle that failed at approximately 1135 on December 27 has been identified as a Van Beest Green Pin Super Shackle.<sup>95</sup> It was one of six that were incorporated into the tow to replace the 85 ton shackles originally intended. As all the remaining 5 shackles were from the same "YP" manufacturing batch, it is assumed that the missing shackle is of that batch as well. During the investigation, Shell provided documentation that suggests that these "YP" batch shackles were purchased from Van Beest in 2007.<sup>96</sup> The work and usage history of the shackles could not be definitively ascertained, other than they were incorporated as part of the KULLUK towing configuration since July of 2012. Testimony suggests that these shackles may not have seen usage prior to this time.

---

<sup>95</sup> The missing shackle is assumed to be of the same make and model of the 5 shackles installed prior to the tow of the KULLUK in July of 2012.

<sup>96</sup> Origin of the Failed Shackle document, prepared by Shell 5/1/2013.



**Figure 54:** Description of Van Beest Green Pin Super Shackles from the manufacturer's catalog. (*Van Beest product catalog available on the internet*)

39. For the 2012 towing operation of the KULLUK there was no equipment history maintained for the shackles, bridle chains and other similar components. The history of use for the individual shackles could not be definitively ascertained, other than they were incorporated as part of the KULLUK towing configuration since July of 2012. The evidence suggests that the shackles remained in their individual locations for the 2012 season and for 5,000 ocean miles of towing. There is no evidence to suggest that the apex shackle was in any other location than connecting the tow pennant to the towing plate and subject to perhaps the most wear, loading and strain than any other shackle in the tow configuration. The apex shackle was installed on the AIVIQ side of the towing plate, connecting the pennant wire to the towing plate. Due to the configuration of the tow, the apex shackle incurred the full loading exerted on the system from the KULLUK to the AIVIQ. No industry standard exists with respect to rotating shackles within a towing configuration from voyage to voyage. In this particular case, such a practice was not considered.

### **Shackle Design and Strength**

40. Green Pin® Super Shackles possess a Working Load Limit (WLL) of 120 tons. This working load limit is to be considered a type of factor of safety, being 1/5 the minimum breaking load of 600 tons. Van Beest could not provide any studies for this particular shackle that were conducted that addressed the results of cyclic loading above and beyond the Working Load Limit. The following information was provided by Van Beest to explain the applicability of this WLL. This product is designed to be utilized in a system in which the WLL is not exceeded and dynamic loads are minimized. It should also be considered that these factors are applied to a shackle in "new" condition.

*"The Working Load Limit should be applied in a straight pull and overloads should not be applied. Side loads should be avoided as the products are not designed for this purpose and the application of a side load may significantly decrease product life. The Working Load Limit for the product corresponds to static use. In case of dynamic use (breaking, accelerations, shocks), the effective stress on the product increases significantly which can lead to product failure"<sup>97</sup>*

<sup>97</sup> Van Beest Green Pin Catalogue, <http://www.vanbeest.nl/gp>.

41. The Proof Load (PL) of this shackle is listed by the manufacturer as 240 tons, or twice the WLL. The U.S. Navy Towing Manual defines the Proof Load of shackles as “the load at which no permanent deformation is observed after the load is released.” Shackles are often tested to their Proof Load prior to distribution by the manufacturer, and Van Beest conducts such tests for all Super Shackles batches prior to sale.

42. The Shackle was of a bow and pin design, with the pin held in place with a nut and cotter key that is inserted through the pin itself to prevent the nut from backing off. The shackle itself has a 3” diameter bow and 3 ¼” diameter pin. Each shackle weighs over 150 lbs. These shackles are comparable with 3” diameter forged steel shackles.

43. These shackles also meet U.S. Federal Specification RR-C-271, Class IVA, Class B anchor shackles. The specification ensures shackles meet defined minimum standards for design/ construction. Of note, it requires that shackles “shall be sufficiently ductile so that, when fractured, the fractured member shall show a permanent distortion before breaking. If the pin fractures, it shall show a permanent bend of not less than 20 degrees. If the body fractures, it shall show a permanent mid-shackle set of not less than 15 percent of the original spread between bows.” This specification ensures a noticeable/ visible indication of fractures prior to the shackle failing. While the 20 degree bend of the pin would be immediately noticeable to a visual inspection, the deflection of the bow may not without a measurement being taken and compared to the manufacturer’s specifications.

44. U.S. Federal Specification RR-C-271 also requires that “each shackle body be permanently and legibly marked in raised or stamped letters on the side of the shackle bow with the identifying manufacturer’s name or trademark, shackle size and Working Load Limit.” This provides a means to readily identify the type and make of each shackle meeting this specification. With these markings, the GL Noble Denton warranty surveyor would have been able to readily identify the make and model of these shackles, with his failure to do so indicative of an incomplete survey of the appliances.



**Figure 55:** Photo of Working Load Limit Stamped on Bow of 120 Van Beest Green Pin® Super Shackle. (USCG Photo)

### **Installation and Inspection Prior to Voyage**

45. 33 CFR Part 164.80 requires the owner, master, or operator to conduct and log the “visual inspection of tackle; of connections of bridle and towing pendant, if applicable; of chafing gear; and of the winch brake, if installed” prior to embarking on voyages over 24 hours. This inspection should be logged prior to each tow.

46. The apex shackle was visually inspected while the chain bridle was connected to the towing plate on shore at OSI shipyard. No measurements, non-destructive testing or other means above and beyond a visual inspection of the shackle was conducted by shore-side personnel, including the warranty surveyor and DelMar Rig Move Supervisor. Because the towing plate, apex shackle and pennant wire were removed as a unit following the arrival of the KULLUK in Dutch Harbor in November, the shackle did not require re-connection. The same is true of the presumably galvanized or stainless steel cotter pin, which is assumed to be the same pin as first installed in Seattle prior to the KULLUK’s tow north to the Beaufort Sea. From photos taken by the warranty surveyor, it would appear that the cotter pin is installed correctly, with one pin bent at an angle to prevent the cotter pin from backing out.

47. Van Beest, the shackle manufacturer, provides the following information with respect to inspections of shackles of this type:

*“It is required that the shackles are regularly inspected and that the inspection should take place in accordance with the safety standards given in the country of use. This is required because the products in use may be affected by wear, misuse, overloading etc. with a consequence of deformation and alteration of the material structure. Inspection should take place at least every six months and even more frequently when the shackles are used in severe operating conditions.”*

There is no record of any inspection of the shackles which were used in severe operating conditions. No checklist, policies, procedures or protocols were provided by Shell who planned the tow or Edison Chouest Offshore who executed the towing operation. The investigation could not identify any pertinent regulations or policies that would require a regular/ established criteria for examining the condition of shackles beyond the “visual inspection” requirement as provided in 33 CFR Part 164.80. Any additional requirement would be contained policies created by the involved parties, of which there is no evidence of such equipment inspection regimes. Additionally, Edison Chouest could not provide documentation required by 33 CFR Part 178 and 180 of these inspections taking place prior to the voyage, which are to be logged in the vessels logbook.

### **Dynamic Loads**

48. Extreme tensions experienced on towlines are dependent on several factors, including the size of the tug and tow; wave size, angle and frequency; average towline tensions; weight and scope (length) of the towline; and towing speed.<sup>98</sup>

49. The AIVIQ’s primary means of absorbing shocks to the towline is through the use of towline catenary. Catenary is simply explained as the sag in the towing hawser which allows the line to rise and fall in the water as a means to absorb shock loads. The weight of the wire rope in addition to the 90 feet of chain in the towline, adds weight to the towline and induces a sag in the line between the tow and towing vessel. An increase in the separation between the tow and

---

<sup>98</sup> U.S. Navy Towing Manual, Revision 3, July 2002.

towing vessel causes the catenary to decrease in depth and the tension on the towline to increase. If the vessels increase the distance between each other and the length of the towline is increased the catenary is maintained and the shock load continues to be reduced. As such, a deep catenary generally results in a lower average tension, allowing the towline to rise and fall to accommodate vessel ship motions.<sup>99</sup> In practical terms, the catenary acts as a type of spring that absorbs fluctuations in towline tension. It acts to compensate between the relative motions of tow and towing vessel.

50. According to the *Navy Towing Manual*, catenary may not be as effective as previously assumed in towing operations to reduce extreme tensions. “It has been suggested that, for the motion frequencies found in most towing situations, the wire towline does not have time to fully resume its former deep catenary when the tension eases before the next surge in tension occurs. The net result over time is that the wire catenary remains flat, thereby providing somewhat less spring than previously thought. Following this line of thought, more of the spring remaining in the system must be attributed to the elastic stretching of the wire itself.” This serves as a warning that should the motions between the two vessels be frequent, that catenary may not provide an effective means for reducing extreme loads on the towline. Evaluation of the AIVIQ’s CCTV footage demonstrates that, at times, the tensioning cycles are frequent, in periods of 8 – 15 seconds, some in as little as 4 – 6 seconds, indicating that the desired catenary effects would be diminished.

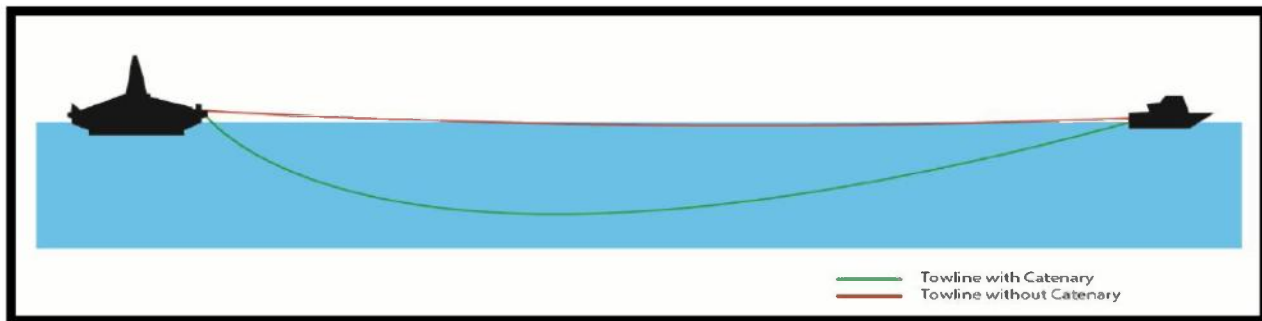


Figure 56: Diagram illustrating the use of catenary in a towing system (USCG Developed)

51. The greater the static load on the towline, governed by the amount of tension (bollard pull) exerted on the towed vessel by the towing vessel, the greater the extreme tension created from dynamic loading. It is incumbent on the towing vessel to be aware of the loads being placed on the towing gear to ensure that dynamic loading does not exceed the capabilities of the towlines and terminal gear being utilized. The AIVIQ was an advanced multi-purpose vessel and should have been expected to monitor steady towline state and extreme towline tension through visually monitoring the catenary as well as utilizing state of the art onboard tension monitoring equipment equipped with alarm set points for the critical towline tension.

**Surge Gear**

52. The AIVIQ sailed with 90 feet of chain on her main towline, and experienced significant towline tension fluctuations prior to the failure of the apex shackle. Failures of the shackle, emergency towing line and pennant wire while utilizing this surge chain configuration in heavy

<sup>99</sup> U.S. Navy Towing Manual, revision 3, July 2002.



seas strongly suggest that this length of surge chain was not adequate to the conditions by failing to provide the shock absorbing effects of towline catenary in the system.

53. Another method to absorb towline high tension is the use of towline that provides stretch in the line itself, such as synthetic lines. With or without the catenary effect, these lines stretch to absorb shocks better than steel towing wire.

54. The planners for the tow of the KULLUK from Kiliuda Bay, Kodiak to Dutch Harbor, Alaska following the grounding of the KULLUK recognized the need for significant shock protection for the towing lines. "The inclusion of a significant amount of chain surge gear, properly positioned, on each towing arrangement is critical to the success of this operation. This is the only way to provide adequate shock-loading protection to the towing gear in extreme conditions where deep water is available. Whist the tow wires will be shortened for departure and arrival, the three tow wires (and in particular the lead tug's towing wire) must be veered to the maximum safe length wherever and whenever practicable."<sup>100</sup> 315 feet of three inch chain was deemed sufficient for this towing operation. This towing operation safely reached its destination of Dutch Harbor despite experiencing gale conditions during a portion of the voyage.

### **Sizing of Shackles**

55. The equipment that made up the primary towing configuration between the AIVIQ and KULLUK was selected as a result of input from a variety of industry experts, including MatthewsDaniel, who conducted a warranty survey for the northbound tows of the KULLUK in 2012. The towing gear was not reassessed for the tow from Dutch Harbor to Seattle in December, and was considered by all involved, including Shell, Edison Chouest and GL Noble Denton, as suitable for the tow.

56. The investigation could not locate any company policies that addressed the standards or guidelines by which the tow configuration was developed. In testimony, Mr. ██████ stated that Shell did not have any written guidelines for determining the size or configuration of tows such as the KULLUK, and relied on industry standards, particularly those of the warranty surveyors.

57. The weakest component, in terms of minimum breaking loads was the 3 inch pennant wire, which connected the towing plate to the AIVIQ's towline. With a breaking load of 556 tons, this wire would theoretically be the first component to fail under high loads.

58. The second weakest component in the system were the shackles, with a minimum breaking load of 600 tons and WLL of 120 tons, which connected the towing plate to the bridle and the pennant wire. Shackle sizing is compared below to IMO, GL Noble Denton and U.S. Navy Towing Manual guidelines to demonstrate the adequacy of utilizing such towing gear for the KULLUK tow.

59. Two different methods exist for sizing shackles within a towing system. IMO, GL Noble Denton and MatthewsDaniel provide guidelines comparing the minimum breaking strength of the shackle with the towing configuration utilized. The U.S. Navy Towing Manual bases their shackle sizing on ensuring the proof load of the shackle meets certain safety factors in comparison against what is anticipate as the steady state tension of the system under tow. Both methodologies provide safety factors, with the U.S. Navy Towing Manual being by far the most conservative.

---

<sup>100</sup> Operations Procedure KULLUK Tow Plan: Kiliuda Bay, Kodiak Island Alaska to Captains Bay, Unalaska, dated 2/11/2013.

60. IMO guidelines found in *MSC Circular 884, Guidelines for Safe Ocean Towing*, contain the following provision in Section 12.4. "All connecting items such as shackles, rings, etc.. should have an ultimate load bearing capacity of minimum 50% in excess of the documented minimum breaking load (MBL) of the towing arrangement to be used." As the pennant wire is the weakest component in the arrangement, the shackles should have an MBL of no less than 825 tons.

61. The *U.S. Navy Towing Manual* states that for towing operations where the tow is controlled on brake, that shackles should possess a safety factor of 5, when compared to the average towline tension. Assuming a towline tension of 166 tons (bollard pull requirement in 5 meter seas/ 40 knot winds/ 1 knot current) the safety factor inherent in the shackle (120 T WWL/ 240 PL) under these conditions would be only 1.4, when compared to the Proof Load. This guidance suggests that the shackles utilized were significantly undersized when compared to these guidelines, and would have a significantly less safety factor under more extreme weather conditions.

62. Regardless of the standard utilized, the sizing of the towing gear must be designed to handle the dynamic loads expected. Depending on which standard is utilized, it is incumbent on the towing vessel to maintain dynamic loading below critical parameters, particularly the proof load of the shackle, where tension in excess of this standard could cause deformities in the shackle, resulting in reduced performance.

#### **AIVIQ Deck Officer Licensing, Experience & Watch System**

63. As the AIVIQ departed Dutch Harbor on December 21 the vessel's bridge officers possessed valid Coast Guard licenses and endorsements for the intended voyage. A license as master or mate of towing vessels endorsed for Oceans authorizes service on oceans and on the subordinate routes of near-coastal and Great Lakes– inland waters (except Western Rivers). In general,<sup>101</sup> the AIVIQs officers could have towed anything, anywhere in the world. Examples of the scope of possible towing operations would include towing a disabled bulk carrier in the South Pacific, a disabled cruise ship with passengers aboard in the waters of the Antarctic or towing an object of unique and unusual design. The issuance of the license and endorsement do not take into account the maritime environment. Towing on the world's oceans, the licensed towing officer can encounter frigid mountainous seas, sandstorms, tsunamis, coral reefs, poorly charted areas where earthquakes have changed the bottom topography and a host of other unique operational considerations. The ocean's license endorsement makes no practical distinction for these conditions which effect towing operations.

64. All of the AIVIQ's bridge officers on this voyage arrived in Alaskan waters in the summer of 2012. This was their first exposure to the harsh marine environment of the Gulf of Alaska and the waters above the Bering Straits in the capacity as officers on a vessel engaged in towing.

---

<sup>101</sup> Except Western Rivers and dependent on the appropriate pilot endorsements and compliance with international and national regulations.

Officer Name	Position	Alaskan Waters Towing Experience	Relevant Merchant Marine Officers License and Endorsement
██████████	Master <sup>102</sup> , Relief Captain	North Slope to Dutch Harbor w/ KULLUK <sup>103</sup> (AIVIQ 2012)	Master of towing vessel upon oceans and western rivers. Master of steam and motor vessel of any gross tons upon oceans. Master of offshore supply vessels of not more than 500 GRT (domestic), 6000 tons (ITC) upon oceans.
██████████	Chief Mate	Dutch Harbor to North Slope w/ KULLUK (AIVIQ 2012)	Master of towing vessel upon oceans and western rivers. Master of steam and motor vessel of any gross tons upon oceans.
██████████	3 <sup>rd</sup> Mate, Towing Specialist	None	Master of towing vessel upon oceans. Master of offshore supply vessels of not more than 500 GRT (domestic), 6000 tons (ITC) upon oceans. Master of steam or motor vessels of not more than 1600 GRT (domestic), 3000 tons (ITC) upon oceans. Third Mate of steam or motor vessels of any gross tons upon near coastal waters.
██████████	2 <sup>nd</sup> Mate	Seattle to Dutch Harbor w/ KULLUK (AIVIQ 2012)	Second Mate of steam or motor vessels of any gross tons upon oceans. Master of offshore supply vessels of not more than 500 GRT (domestic), 6000 tons (ITC) upon oceans.
██████████	3 <sup>rd</sup> Mate, Towing Specialist	Dutch Harbor to Seattle w/ KULLUK (NANUQ 2011) Seattle to Dutch Harbor w/KULLUK (AIVIQ 2012)	Master of towing vessel upon oceans. Third Mate of steam and motor vessel of any gross tons upon oceans. Master of offshore supply vessels of not more than 500 GRT (domestic), 6000 tons (ITC) upon oceans. Master of steam or motor vessels of not more than 1600 GRT (domestic), 3000 tons (ITC) upon oceans.

**Figure 57:** AIVIQ Bridge Officer Experience and License Endorsements (*USCG Developed*)

65. The AIVIQ sailed from Dutch Harbor with the KULLUK in tow utilizing a bridge watch system that included the pairing of senior officer with a junior officer with significant anchor handling and towing experience. The Senior Officers filled the position of Senior Officer in Charge of the Navigation Watch. The Junior Officers were 3<sup>rd</sup> Mates, and were referred to as “Anchor Captains”, with their primary responsibilities being to provide towing expertise to the watch.

66. During the course of the investigation, Edison Chouest could not produce any written policies or procedures that would instruct the members of the bridge watch on what would be expected while towing a vessel (such as the KULLUK). During testimony, the AIVIQ Master stated that he did not specifically advise the bridge watch officer with respect to how he wanted the KULLUK towed. He relied on the judgment and experience of the bridge officers, particularly the 3<sup>rd</sup> Mate “Anchor Captains” to monitor the tow and advise him should there be a concern. Following the failure of the apex shackle on December 27, the AIVIQ Master began including specific instructions in his night orders that addressed towing expectations. Mr. ██████████ 3<sup>rd</sup> Mate, also testified that he received no guidance with respect on how much maximum tension should be placed on the towline and relied on his experience and judgment.<sup>104</sup> The lack

<sup>102</sup> 15.610 Master and mate (pilot) of towing vessels.

(a) Except as provided in this paragraph, every towing vessel of at least 8 meters (at least 26 feet) in length, measured from end to end over the deck (excluding sheer), must be under the direction and control of a person holding a license or MMC officer endorsement as master or mate (pilot) of towing vessels or as master or mate of vessels of greater than 200 gross register tons holding either an endorsement on his or her license or MMC for towing vessels or a completed Towing Officer's Assessment Record (TOAR) signed by a designated examiner indicating that the officer is proficient in the operation of towing vessels. This does not apply to any vessel engaged in assistance towing, or to any towing vessel of less than 200 gross register tons engaged in exploiting offshore minerals or oil if the vessel has sites or equipment so engaged as its place of departure or ultimate destination.

<sup>103</sup> Sailed as Chief Mate during voyage.

<sup>104</sup> 3<sup>rd</sup> Mate ██████████ Testimony, transcript page 803.

of towing guidance and expectations, either verbal or written for this critical towing operation, resulted in this outcome. The practice of using officers with less Gulf of Alaska winter towing expertise would create an environment whereby the safety of the tow was jeopardized by towing operations that would greatly exceed the working limits of the towing gear, in particular the apex shackle. (See Section titled *Extreme Towline Tension* below)

67. The watch system for the bridge officers was set up for twelve hour watches, 1200 hours to 2400 hours, with the Master generally day working 0600 to 1800 hours but on call twenty four hours a day.

“46 CFR 15.705 Watches. (b) Subject to exceptions, 46 U.S.C. 8104 requires that when a master of a seagoing vessel of more than 100 gross tons establishes watches for the officers, sailors, coal passers, firemen, oilers and water tenders, the personnel shall be divided, when at sea, into at least three watches and shall be kept on duty successively to perform ordinary work incident to the operation and management of the vessel.”

68. One of the exceptions for this requirement is when the vessel is on a voyage of less than 600 miles. The AIVIQ’s voyage took her on a continuous route for over 1,700 nautical miles from Dutch Harbor, Alaska to the Seattle, Washington area.

#### **AIVIQ Towing Winch and Monitoring Equipment**

69. The AIVIQ’s towing winch system contained an advanced computerized monitoring and control system manufactured by Rolls-Royce called the Towcon RT. This system contained a means to monitor strain/tension of the towline (in Tons), tow line length, hydraulic pressure, among others, and would alarm should any of the pre-set limits be exceeded. With respect to tension monitoring, the user could easily set any strain/ tension limit by which an alarm would be activated. No user set tension settings were established, and the only high tension alarm active was a manufacturer set alarm that would activate upon reaching 50% of the tensile strength of the main tow drum. The tensile strength was set prior to the voyage at 600 tons, indicating that the alarm would activate at 300 tons of tension. See Figure 58.

70. In accordance with the manufacturer and in testimony of 3<sup>rd</sup> Mate ██████ the alarms were audible throughout the bridge and would require an acknowledgement of the alarm on the Towcon monitoring alarm screen. The alarms would appear in table format, with the most recent on top. Active alarms that require acknowledgement appear as red, alarms that are still active but have been acknowledged appear as yellow, and alarms that are no longer active appear as white.<sup>105</sup>

71. The Towcon system was located on the after portion of the AIVIQ’s bridge, overlooking the working deck aft. The AIVIQ also had four CCTV cameras positioned so the bridge crew could view the aft working deck at all times. Images from these CCTV cameras could be viewed from any number of TV monitors all viewable from the forward navigational control area of the bridge. These cameras were installed on all four corners of the working deck (Port Forward, Port Aft, Starboard Forward, and Starboard Aft) and provide a clear view to visually monitor the towing line and personnel working.

---

<sup>105</sup> Testimony of Mr. ██████ formal board, transcript page 795-796.

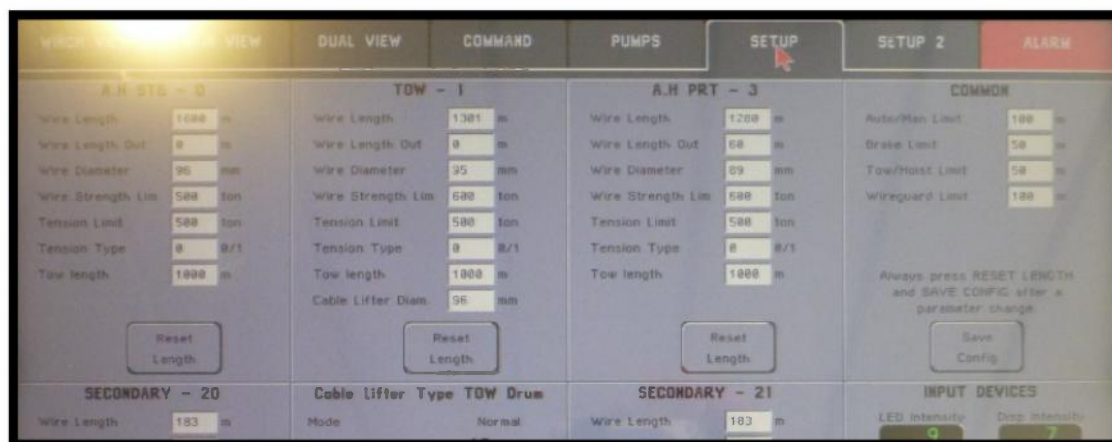


Figure 58: Photo of Towcon Setup screen showing “wire strength limit” for main towing drum is set at 600 tons. (USCG Photo)

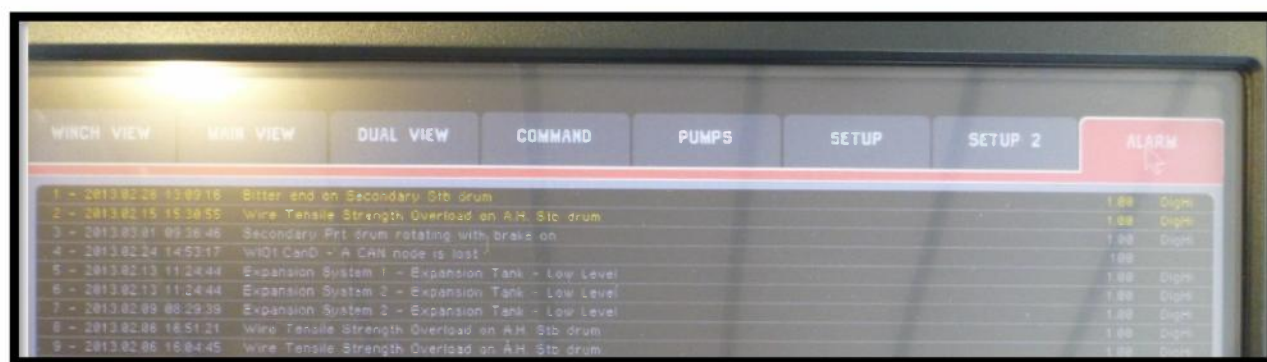


Figure 59: Towcon alarm screen indicating alarms received on the bridge monitor, requiring acknowledgement of the bridge officers. Alarms indicated are for a later time period than investigation scope. (USCG Photo)

**Extreme Towline Tension – December 27, 2012**

72. Following the casualty, data logs were extracted from the Towcon system and provided to Rolls-Royce for analysis and decryption of the data. Rolls-Royce provided a document containing their analysis of the data, showing that the “Wire Tensile Strength for Tow Drum” alarm activated on 38 separate occasions between the hours of 0534 and 1129 on December 27. In testimony, 3<sup>rd</sup> Mate [REDACTED] on watch during this time period, stated that he did not receive any of these alarms. He did state that he had received numerous wire tensile strength overload alarms for the starboard anchor handling drum. According to the Rolls-Royce supplied data, there was only one record for this alarm on December 27, occurring at 0535. This suggests that 3<sup>rd</sup> Mate [REDACTED] may have mistaken the overload alarm for the main tow drum for the overload alarm for the starboard anchor handling drum, as the starboard anchor handling tension alarm had a known fault and would consistently read tensions above 300 despite being unused at the time.

73. There are three actions that the towing vessel can take to reduce tension on the towline. The first is to pay out more towline in an attempt to increase the catenary. The deeper the catenary, the more it will be able to absorb dynamic shocks due to the differing movements between the towing and towed vessel. The AIVIQ’s towing log, backed up by testimony from

the bridge watch, indicate that the vessel payed out a total of 110 meters (361 feet) of towline during the morning hours of December 27 in an attempt to decrease the observed loading on the towline. The AIVIQ had nearly 1298 meters (4,270 feet) of total towline available on the main winch.

74. The second action that can be taken to reduce towline tension is for the towing vessel to reduce speed, therefore reducing the hydrodynamic drag on the towed vessel as it moves through the water and waves. Of all the options, slowing the towing vessel is typically the most effective means of reducing dynamic loading. Testimony indicates that the AIVIQ did slow the vessel at some point during the morning of December 27. This reduction in speed was not documented in the vessel logs, and therefore the exact time of speed reduction and the overall reduction to engine loading is not known. Also, data provided from the Dynamic Positioning System did not record any speed reduction, indicating that the propeller pitch remained at approximately 80% with constant engine rpms until the time of the shackle failure.<sup>106</sup>

75. The third action that can be taken to reduce towline tension is for the towing vessel to come to a new heading, which may decrease the wave action on the towed vessel and possibly reduce extreme tensions. No notable course changes were ordered by the towing vessel to reduce towline stress prior to the failure.

76. The following figure was created to demonstrate the relationship between the Towcon alarm logs and actions taken in accordance with the vessel’s logs.

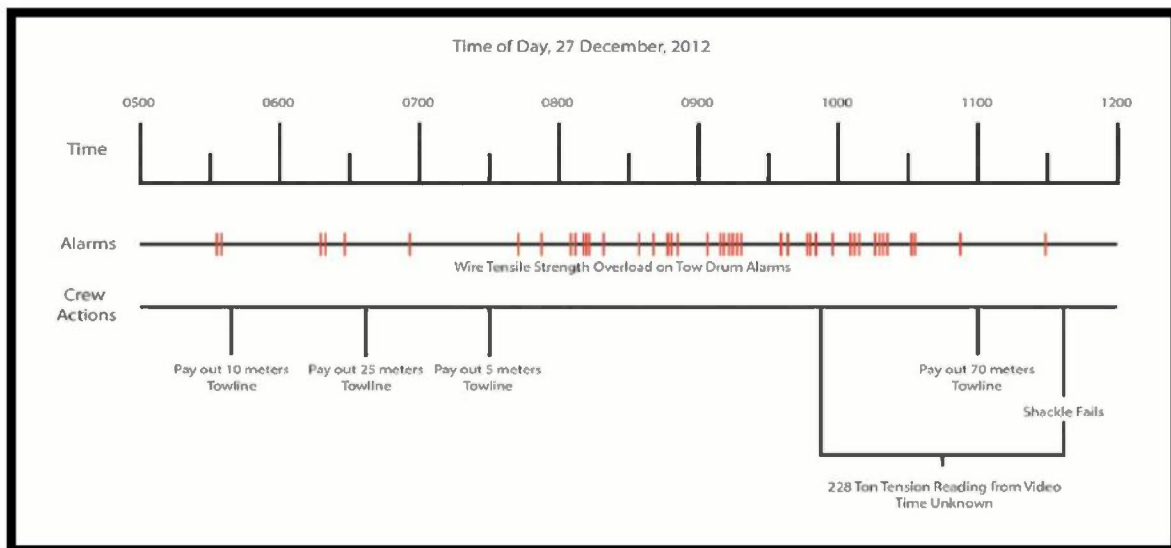


Figure 60: Summary of main towing drum data for the morning December 27, 2012 indicating time, alarms received towline length and shackle failure.<sup>107</sup> (USCG analysis)

77. Examination of the CCTV aboard the AIVIQ and monitoring the towline indicates “snatching” (tensioning/loosening cycle) of the tow wire cyclically over a period of time, indicating dynamic loading to the towline and towing accessories. Periods of lower tension are indicated as the tow wire rides on the stern roller. Periods of higher tension are indicated as the

<sup>106</sup> Data provided by Marine Technologies, Inc.

<sup>107</sup> The Towcon alarm data is assumed to be Alaska Time (AKST), Edison Chouest could not verify the time reference in this data.

tow wire goes taut and comes off the roller and is suspended into the air above the deck. Higher tensions are also indicated by a loss of catenary between the towing vessel and tow.

[Continued on next page]



**Figure 61:** Starboard aft CCTV stills showing fluctuations in towline tension. Still on left shows lower tension at 10:12:42. Still on right shows high tension at 10:12:48. (*AIVIQ CCTV Provided by ECO*)



**Figure 62:** Starboard aft CCTV stills showing fluctuations in towline tension. Still on left shows lower tension at 11:17:14. Still on right shows high tension at 11:17:18. (*AIVIQ CCTV Provided by ECO*)



**Figure 63:** Starboard aft CCTV stills showing fluctuations in towline tension. Still on left shows lower tension at 11:31:49. Still on right shows high tension at 11:31:58. (*AIVIQ CCTV Provided by ECO*)

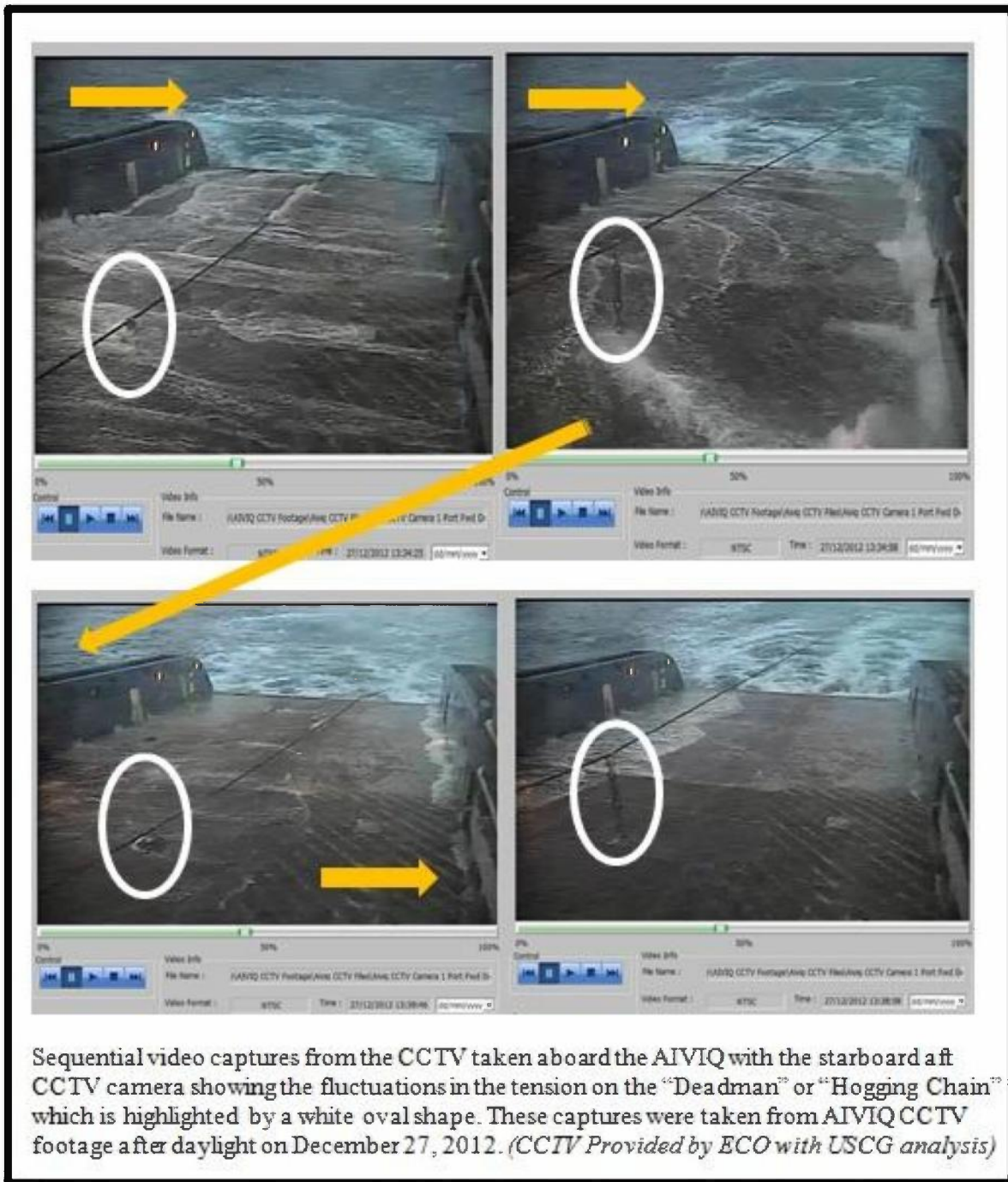




**Figure 64:** Starboard aft CCTV stills showing fluctuations in towline tension. Still on left shows lower tension at 11:32:06. Still on right shows high tension at 11:32:10 at the time of the shackle failure. *AIVIQ CCTV Provided by ECO*



**Figure 65:** Port Forward CCTV stills showing fluctuations in towline tension. Still on left shows high tension at 10:54:48, demonstrated by the stiffness of the hogging chain (bottom right of still) and towline appearing to lead nearly horizontally toward KULLUK. Still on right shows low tension at 10:54:52, a mere 4 seconds later, with a slack Deadman chain and towline on the deck. *(AIVIQ CCTV Provided by ECO)*



**Figure 66** – Movement of the Deadman or Hogging Chain aboard the AIVIQ on the morning of December 27, 2012.



**Figure 67** – Movement of AIVIQ towline and tension on the line on the morning of December 27, 2012.

78. As configured, the shackle that failed incurred the full load of the towline between the KULLUK and AIVIQ. The bridle shackles on either side of the towing plate generally shared the load. From the findings, the tow winch strain monitoring system logged 38 separate occasions during the morning of December 27 of towline loading over 300 tons. Additionally, video evidence from the 3<sup>rd</sup> Mate [REDACTED] on watch shows load fluctuations from 28 to 228 tons within the period of a few seconds, providing further proof of extreme fluctuations in the towline tension while towing the KULLUK. This event would not be logged in the towing system, so it is unknown on how many occasions the readings were high but went unrecorded as an alarm as they did not meet the 300 ton alarm threshold.

79. This analysis strongly suggests that the bridge watch of the AIVIQ did not take timely or appropriate action to reduce the fluctuations in tension observed on the towline and associated equipment. The paying out of towline and reported speed reduction of the towing vessel still resulted in extreme towline tensions over the course of six hours during the morning hours of December 27<sup>th</sup>, immediately prior to the failure of the apex shackle.

### Shackle Testing

80. Following the casualty, three of the shackles underwent tensile tests at the testing facilities at Holloway Houston (Houston, TX) to determine if the shackles would still meet the minimum breaking load expectations. In addition, a new Green Pin Super Shackle was subjected to breaking load tensile tests for comparative purposes. This test measures the overall strength of the shackle against new shackle performance criteria testing conducted by the manufacturer. Testing results significantly below the minimum breaking load might indicate weakening of shackle through cyclic loading fatigue or other defect in the metal itself. All results of the testing indicate that the shackles nearly met or exceeded the manufacturer's minimum breaking load criteria.

81. Additional non-destructive and mechanical testing was conducted at the testing facilities of Exova Houston. The material properties determined from tensile, Vickers Hardness and Charpy Impact tests were within the expected parameters. The usefulness of the testing conducted was limited due to the fact that in order to make a conclusive finding, the actual failed shackle would require testing.

### Failure Analysis

82. Because the shackle was lost at sea, **the exact nature of the failure cannot be determined**. There are two possible causes. First, the cotter pin fastener for the shackle failed (or fell out) allowing the nut of the shackle bolt to come undone. Figure 12 shows that the cotter key was installed, and one pin was bent over to prevent failure. The second would be that the shackle failure was due to a structural failure of the metal itself, either through cyclic loading fatigue or other defect in material. The loads exerted on the shackle, in excess of 300 tons during the voyage immediately prior to the failure suggest fatigue to be a significant contributor to the failure.

### AIVIQ Material Condition

#### Previous Events during Tow of the KULLUK

83. The AIVIQ had a number of incidents that affected her seaworthiness and machinery capabilities during previous tows of the KULLUK.

84. During the investigation it was discovered that between August 30<sup>th</sup> and September 1<sup>st</sup>, 2012, the AIVIQ encountered significant wind and seas while towing the KULLUK north to the Beaufort Sea. During this time frame, the AIVIQ took on a significant amount of water on the back deck. This water entered the safe decks and winch room of the vessel causing damage to numerous systems, including the daughter craft, safe deck heaters, vent blowers, cranes and fire main valve stems. Additionally, tank vents located in the safe deck area were submerged.<sup>108</sup> Information received also suggests that the AIVIQ experienced a sustained list at times reaching 20 degrees during this period due to water intrusion into interior spaces.<sup>109</sup>

85. This event led to the Master of the AIVIQ to recommend and initiate modifications to the vessel prior to the AIVIQ's departure from Dutch Harbor on December 21, 2012 to the management of Edison Chouest. These repairs included the installation of removable doors for the openings to the anchor handling winch room and the removal of hinged scupper plates from the aft deck to prevent them freezing and failing to drain water shipped on the aft working deck. Several other recommendations made, including the installation of doors for the safe deck area and the raising of the tank vents to prevent submersion were not completed prior to departure.

86. Additionally, the investigation learned that on November 10, 2012, while towing the KULLUK south from the Beaufort Sea to Dutch Harbor, the AIVIQ suffered an electrical "blackout" and failure of their #4 MDE due to crankshaft and bearing damage. This damage rendered the engine unusable during the remainder of the tow.

87. Regulations contained in 46 CFR 4.05-1 contain provisions for immediately reporting certain events to the Coast Guard. These requirements contain provisions that address when a vessel experiences a marine casualty involving:

"(3) A loss of main propulsion, primary steering, or any associated component or control system that reduces the maneuverability of the vessel; (4) An occurrence materially and adversely affecting the vessel's seaworthiness or fitness for service or route, including but not limited to fire, flooding, or failure of or damage to fixed fire-extinguishing systems, lifesaving equipment, auxiliary power-generating equipment, or bilge-pumping systems."

The flooding event of August 30, and the blackout and engine failure that took place on November 10<sup>th</sup> would, on their face, have required marine casualty reporting to the Coast Guard in accordance with the regulations.

88. Additionally, 33 CFR Part 160.215 requires reporting of hazardous conditions to the Coast Guard, with a hazardous condition defined as:

"...any condition that may adversely affect the safety of any vessel, bridge, structure, or shore area or environmental quality of any port, harbor, or navigable waterway of the United States. It may, but need not, involve collision, allision, fire, explosion, grounding, leaking, damage, injury or illness of a person aboard, or manning shortage."

---

<sup>108</sup> Edison Chouest document titled "Storm Damage Lessons Learned", dated 12/13/12.

<sup>109</sup> E-mail from Captain [REDACTED] to [REDACTED] dated December 17, 2012.

The Findings of Fact contain a detailed list of adverse mechanical conditions aboard AIVIQ prior to the commencement of the voyage under investigation. (*See sections 53 and 54 KULLUK ROI Findings of Fact*)

89. The Coast Guard was not notified of the storm damage, blackout, or engine failure prior to the AIVIQ departing Dutch Harbor with the KULLUK in tow on December 21, 2012. ABS was notified of the engine failure, and repairs to the engine were completed and a survey was conducted by ABS to approve the repairs prior to the AIVIQ's departure from Dutch Harbor. Coast Guard Sector Anchorage has initiated a separate marine casualty investigation of these previous events.

### **AIVIQ Engineering Casualty**

The Coast Guard Marine Safety Center provided a report that contains a thorough analysis of the AIVIQ's engineering casualty, included in this investigative report as Appendix 1. This section of the analysis draws heavily on their conclusions as well as other investigative findings.

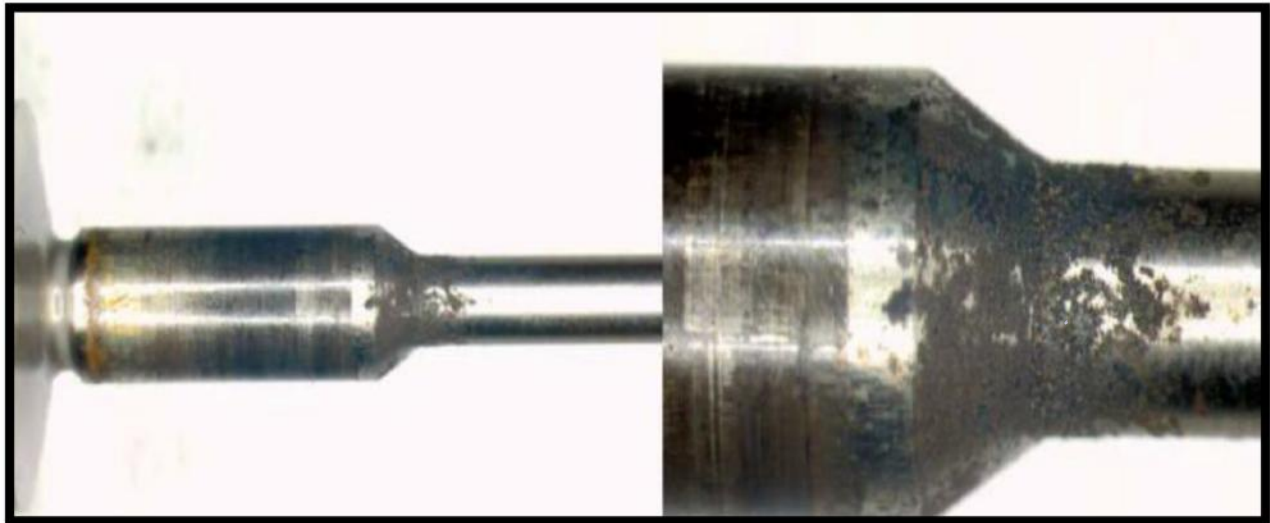
#### **Fuel Injector (Injector) Analysis**

90. Several main engine fuel injectors were examined following the casualty. These fuel injectors are a critical engine component that feeds fuel oil into the cylinder of a marine diesel engine at precise pressure and combustion patterns. An injector examined by the Southwest Research Institute (SWRI) on behalf of Edison Chouest Offshore indicated that there was extensive internal corrosion which resulted in the injector check valve (pintle) becoming seized in the injector tip nozzle assembly. The "frozen" pintle rendered the injector inoperative. Four injectors examined by Caterpillar, the engine manufacturer, showed similar corrosion to internal components. Metallurgical analysis using Energy Dispersive Spectroscopy confirmed high content of iron and oxygen (i.e. rust) and high levels of sodium, chlorine, calcium, and potassium on all internal parts. These elements are major components of seawater.

91. The Coast Guard Marine Safety Center concluded that "the extent of corrosion may be an indication that at least some level of contamination of fuel oil with water and/or seawater was ongoing and may not have occurred over a period of just a few days".<sup>110</sup>

---

<sup>110</sup> Marine Safety Center Analysis of M/V AIVIQ Marine Casualty document, Appendix 1, dated 26 November page 4.



**Figure 68:** Two photos showing significant corrosion of injector check valve. (Provided by Caterpillar)

### **Fuel Oil (Low Sulfur Diesel Fuel) Analysis**

92. The Coast Guard arranged for the diesel fuel samples to be tested by DNV Petroleum Services. Testing of samples collected found both sodium and magnesium in both #1 Port and Starboard Day Tanks, which were the primary fuel sources for the main engines and generators at the time of the casualty. The presence of these two elements indicates seawater contamination. Additionally, major constituents of seawater (NaCl, Na, Cl, Ca, and Mg) were found on main engine filter elements and internal injector components and what appeared to be biological growth was noted on in fuel samples and filter elements.<sup>111</sup>

93. DNV Petroleum testing found 0.5% water (by volume) in the #1 Port Day Tank sample. The manufacturer of the main and ship service diesel engines; Caterpillar publishes detailed fuel specifications which limit water content of diesel fuel to a maximum of 0.05%. The amount of water contained in this sample was nearly 10 times the allowable amount from the manufacturer's specifications.<sup>112</sup>

94. DNV Petroleum analysis of fuel samples taken during bunkering or loading of fuel onboard the AIVIQ prior to the voyage indicate that a sample from the first 1000 gallons of fuel oil loaded at Delta Western met specifications, was free of water, and no contamination was noted.<sup>113</sup>

### **Design Issues**

95. The AIVIQ's fuel oil storage tanks, including settling and #1/#2 Port and Starboard Day Tanks are connected to a common vent and overflow system. "Two common vent/overflow headers run fore and aft, one Port and one Starboard. Each vent/overflow header has four vents, two forward and two aft. Each vent/overflow header drains into a common Fuel Oil Overflow

<sup>111</sup> Id.

<sup>112</sup> Id.

<sup>113</sup> Id.

Tank via an overflow alarm sensor arrangement. Vent/overflow piping from each fuel oil tank connects to a vent/overflow header via a gooseneck. The goosenecks extend above the Main Deck to prevent sloshing fuel within tank(s) from reaching the vent/overflow header.”<sup>114</sup> The four vents discussed above are contained in the safety deck area, approximately 30 inches above the deck.

96. Due to the AIVIQ design, water regularly washes onto the aft working deck area during high seas from area of the stern roller, particularly while towing. This seawater then tends to be carried back and forth across the deck as the AIVIQ rolls. The safety deck area, which comprises tunnel like enclosures both port and starboard the length of the working deck, are exposed to water intrusion through the open hatchways as well as the freeing ports and scuppers, which are not equipped with hatches or doors. The hinged freeing port covers were designed to allow water to run off the deck and safe decks and to prevent the ingress of water when the vessel rolled. The vessels crew removed these hinged covers prior to the start of the voyage.

97. Analysis of the CCTV footage shows that between the hours of 1400 and 2400 on December 27, the AIVIQ routinely took water onto the aft working deck in a nature similar to the stills contained as Figure 70 and 71. This would create an environment whereby the tank vents, located in the safety deck area would be subject to water immersion, potentially being completely submerged at times. Any failure of the check type vents would allow water into the common vent/overflow header.

98. Racor RVFS-1 fuel filters are provided on the fuel supply line for each main engine. Sight glasses or water monitoring probes can be installed to indicate water contamination, but neither were installed.<sup>115</sup> This would require routine draining of the filter to check for the presence of water, a practice which cannot be verified occurred within the routine watch system of the engine room. “The manufacturer of the filter stated that if water was not drained from the filter bowl then water could pass through the filter element and into the engines fuel system. Additionally, the Chief Engineer testified that all engines maintained good fuel pressure and normal filter differential pressures prior to the casualty. It appears the Chief Engineer incorrectly assumed that water in the fuel would cause high differential pressure in the fuel filters. The filter manufacturer identified that if the RVFS-1 primary filter accumulated water there would be no significant increase in pressure before the water would be passed through the filters to the engines.”<sup>116</sup>

### **Fuel Management Practices**

99. In accordance with the AIVIQ Preliminary ACCU Qualitative FMEA and DVTP, the fuel system is to be split at all times between the four fuel oil day tanks, with one main engine and one ship service diesel generator supplied by each day tank. These same documents indicate that by following this required practice that the Worst Case Failure for fuel oil service system would be limited to the loss of one main engine and one ship service diesel generator.<sup>117</sup> The vessel did not operate under this configuration, and instead operated under a split configuration with the #1 Port Daytank feeding the portside engines and generators, and the #1 Starboard Day Tank feeding the starboard engines and generators. Had the AIVIQ operated under the approved fuel system configuration, it is not clear whether it would have mitigated or prevented the loss of the main engines, as the vent header system would still offer a means for water intrusion directly

---

<sup>114</sup> Id. at 5.

<sup>115</sup> Id. at 11.

<sup>116</sup> Id. at 16.

<sup>117</sup> Id. at 13.



into all Day Tanks, regardless of the configuration. The AIVIQ Chief Engineer was unaware of the requirement to comply with the ACCU Qualitative FMEA and DVTP fuel configuration.

100. Following an audit of the AIVIQ's Safety Management System following the casualty, Edison Chouest acknowledged they were not operating in accordance with the approved configuration and would follow the procedures going forward.

101. The only means onboard the AIVIQ for testing fuel oil was water gauging paste, while other means of testing for water in fuel was available. "Ultra Low Sulfur Diesel Fuel is highly hygroscopic. As noted earlier, CAT fuel specifications in reference (k) require water content to be a maximum of 0.05%. It appears there were no means available for the crew to check fuel oil samples taken from the settling or day tank drains for water content (i.e. water dissolved in the fuel oil). Water gauging paste can't be used to determine the amount of water absorbed in the fuel oil."<sup>118</sup>

102. Statements from the 1<sup>st</sup> Assistant Engineer indicate that the crew did not check fuel oil for water on a regular basis. The methodology for checking fuel oil for water, when conducted, was insufficient for properly detecting water that had been absorbed into the fuel.

103. On the day of the casualty, fuel oil purifier alarms were indicated. Ships logs indicate that the port aft purifier was operating at a greatly reduced capacity (7 gpm vs. 17 gpm). This is consistent with water contamination, as water in fuel oil would have required additional energy to heat, and led to a recirculation through the purifier heater, reducing the output.<sup>119</sup>

104. Evidence strongly suggests that the fuel overflow tank was full prior to the AIVIQ's engineering casualty that occurred on December 27. The circuit breaker for the fuel oil overflow tank alarm had been secured for unexplained reasons sometime after midnight on December 26. The fuel overflow tank was not pumped down until after the casualty. The failure to immediately pump this tank down may have resulted in the tank/ overflow header becoming full of contaminated fuel, filling the vent/ overflow header and offering an opportunity to contaminate other fuel tanks, including the day and settling tanks. It also strongly suggests that the AIVIQ Chief Engineer did not realize the potential for water intrusion through the vents, despite the fact that he had recommended in his maintenance report that the following log appears in his maintenance report to Edison Chouest on December 25<sup>th</sup> - "Tank Vents in both Port and STBD safe deck passages will need to be removed and inspected for damaged caused by storm, some vent screens and vent check balls will be required."

---

<sup>118</sup> Id. at 16.

<sup>119</sup> Id. at 11.



**Figure 69:** Photo depicting location of hatchways into safety deck from aft working deck of AIVIQ. *(USCG Photo and Developed)*



**Figure 70:** (left) Still from Starboard Stern CCTV showing seawater flowing over aft working deck and entering safety deck area at 15:16:47 on December 27. (right) Safety deck area at 15:16:55 after water clears from deck. Port side aft safety deck hatchway is visible. *(AIVIQ CCTV Provided by ECO)*



**Figure 71:** (left) Still from Port Forward CCTV showing seawater flowing over aft working deck and entering safety deck area at 14:39:09 on December 27. (right) Similar occurrence at 14:49:19 on December 27. (AIVIQ CCTV Provided by ECO)

**Weather Encountered**

105. The weather experienced during the tow of the KULLUK, beginning on December 26, was extreme. No less than four strong low pressure systems swept through the area, creating difficult conditions, particularly for the response vessels attempting to assist the MODU. Seas in excess of 20 feet and wind in excess of 35 knots prevailed during the response efforts. Seas in excess of 30 feet and winds in excess of 50 knots were recorded by on scene vessels. The conditions encountered during the response are rare outside tropical cyclones that occur throughout the globe, but common in Gulf of Alaska waters, particularly in the winter.

106. The Beaufort scale is commonly used in categorizing conditions at sea. The scale extends from Force 1 through Force 12. A brief description is provided below that address wind speed and impact on wave heights.

107. All equipment failures and periods where the total bollard pull of the responding vessels proved inadequate to control the KULLUK’s drift occurred during periods of heavy weather, with winds and seas in in excess of 40 knots and seas greater than 20 feet.

Beaufort #	Wind (kts)	WMO Class	Wind Effect on Water
0	<1	Calm	Sea surface smooth and mirror-like
1	1-3	Light Air	Scaly ripples, no foam crests
2	4-6	Light Breeze	Small wavelets, crests glassy, no breaking
3	7-10	Gentle Breeze	Large wavelets, crests begin to break, scattered whitecaps
4	11-16	Moderate Breeze	Small waves 1-4 feet, numerous whitecaps
5	17-21	Fresh Breeze	Moderate waves 4-8 feet, many whitecaps, some spray
6	22-27	Strong Breeze	Large waves 8-13 feet, whitecaps common, more spray
7	28-33	Near Gale	Sea heaps up, waves 13-19 feet, white foam streaks off breakers
8	34-40	Gale	Moderately high waves 18-25 feet, foam blown in streaks
9	41-47	Strong Gale	High waves 23-32 feet, sea begins to roll, dense streaks of foam
10	48-55	Storm	Very high waves 29-41 feet with overhanging crests
11	56-63	Violent Storm	Exceptionally high waves 37-52 feet, foam patches cover sea
12	64+	Hurricane	Waves over 45 feet, air filled with foam, visibility greatly reduced

**Figure72:** Beaufort Scale relating to the wind effect on water (Public Domain)

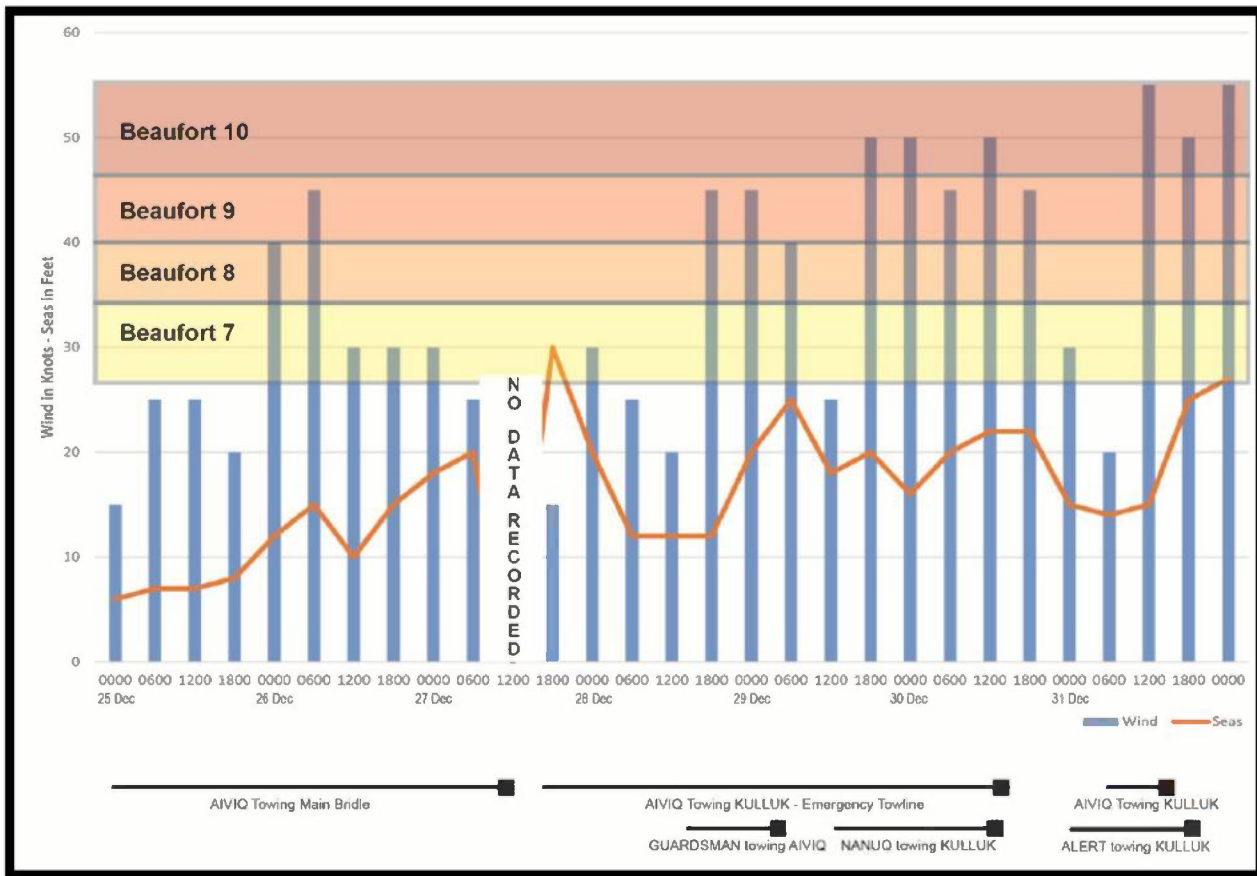


Figure 73: Diagram containing wave height and wind speed from December 25 – 31. Data extracted from available vessel logs. (USCG Analysis)

**Response Vessels**

108. All vessels that responded to assist the KULLUK proved either deficient in bollard pull capabilities or possessed inadequate or ineffective towing equipment to reduce shock loading for the shallow water environment of Albatross Bank. The following sections address deficiencies in the towing capabilities or operations of the assisting vessels participating in the tow.

**ALEX HALEY**

109. The Cutter ALEX HALEY was on patrol in the area and was the first vessel to arrive onscene. As a medium endurance cutter the ALEX HALEY’s crew was well trained to respond to a wide variety of emergency situations at sea. However, they were not equipped with the sophisticated commercial grade towing equipment required for the complexity of this particular emergency towing operation. They were attempting to connect a towline to the bow of the AIVIQ while the AIVIQ, with limited propulsion power, was being pulled astern by the KULLUK. The crew was attempting to establish tow with a heavy nylon which did not float connected to long messenger lines. The messenger lines enabled the crew of the AIVIQ to pull the heavy hawser to the AIVIQ. The crews of the AIVIQ were trying to heave or pull in the

towing hawser onto the high bow of the AIVIQ in heavy seas and in this emergent situation communications were less than ideal. Due to the movement of the AIVIQ and the ALEX HALEY and high wind and sea states the ALEX HALEY continued to slack out the towing gear which comprised the hawser and the messenger lines. Despite maneuvering to stay close to the AIVIQ and control the paying out of the hawser, this attempt to establish tow of the AIVIQ and KULLUK was unsuccessful.

110. The ALEX HALEY's towing operation was not successful for the following reasons:

- a. The operation was a high risk endeavor which would be conducted at night, with high winds and seas and attempting to tow a large commercial vessel which was attempting to tow a conically shaped drilling rig.
- b. The ALEX HALEY and the vessel that was to be towed were dissimilar in design with greatly different wind and sea driven drift rates. In addition, the height of the ALEX HALEY's stern and the high bow of the AIVIQ presented challenges in the AIVIQ crew retrieving the associated tow lines.
- c. Both the ALEX HALEY and the AIVIQ were hampered by the inability to maneuver and stay close enough to effectively and safely pass the messenger and later the heavy hawser. As the vessels separated the ALEX HALEY crew paid out hawser to allow the crew on the forward deck of the AIVIQ to connect the towline to the AIVIQ towing equipment forward.
- d. The ALEX HALEY towline was 8 inch nylon which is heavy, hard to handle and does not float. Modern high tech towing lines have the strength of steel with smaller overall diameter. The tow hawsers used for this type of emergency work have the added advantage of being lighter, easier to handle, and typically float on the surface of the water. They are the standard of the commercial towing industry. With lighter weight high strength synthetic towlines the messenger lines are also easier to handle.
- e. Communications between the ALEX HALEY and the AIVIQ crew on deck was less than ideal.
- f. The ALEX HALEY was maneuvering so as to not foul their towline or messenger at the same time the ALEX HALEY crew was paying out hawser. Despite this maneuvering the towline and messenger entered the storm tossed water and fouled the port propeller and shaft.

### GUARDSMAN

111. The GUARDSMAN was a typically configured traditional tug with a conventional propulsion system. She established tow of the AIVIQ in challenging sea conditions, succeeding in slowing the drift of both vessels, but being constantly pulled astern due to the towing resistance of both vessels. The GUARDSMAN utilized a fairly robust towing package, utilizing 135 feet of surge chain and a synthetic towing line connected to her 2 ¼ inch main towing wire.

112. Over the course of the tow, weather became severe, with southerly winds recorded at nearly 50 knots and seas between 20 and 25 feet. The main towing wire connecting the GUARDSMAN to the AIVIQ failed on the morning December 29 having been subjected to the strain of towing two large, independently moving vessels astern in significant sea conditions over a period of 13 hours. The GUARDSMAN succeeded in ensuring the AIVIQ held course into the seas, but was not suitable to stop the drift of both the AIVIQ and KULLUK with only 75 tons of bollard pull. The GUARDSMAN's Master attributes the failure of the towline to a change in motion of the KULLUK due to the survival anchor slowing, or stopping, the movement of the KULLUK momentarily, resulting in extreme towline tensions in heavy seas. While the investigation revealed that the survival anchor may have been deployed during the period, significant slowing or stopping of the KULLUK cannot be accurately verified. Tensile testing of a portion of the GUARDSMAN's 2 ¼ inch towline following the casualty indicated that the

towline possessed a breaking load of 246 tons, which exceeded the manufacturer's minimum breaking strength.<sup>120</sup>

### **NANUQ Towline Failure**

113. The NANUQ was an Offshore Supply Vessel that successfully towed the KULLUK with a wire towline without surge gear during challenging weather conditions until failure of the towline on December 30. While the NANUQ was outfitted with a capable winch and a 2 ¼ inch towline comparable to the GUARDSMAN's, several factors worked against the vessel's efforts.

114. The NANUQ responded without any type of surge protection for their main towline. The vessel did not have surge chains or pre-fabricated synthetic rope to reduce shocks to the towline as a whole. Concerned about this, the NANUQ was able to fashion a type of grommet using onboard nylon line, but the decision was made not to use this improvised shock line due to concerns over suitability. This deficiency was so pronounced that the GUARDSMAN did not consider itself able to tow the KULLUK following the loss of their surge gear, even though they had another wire towline available.

115. The NANUQ connected directly to the KULLUK's 3 ½ inch mooring wire, which is typically not suitable for towing as it does not lead from the KULLUK's deck, but from a submerged fairlead beneath the hull. The use of this line to tow the KULLUK was an improvised method for towing the vessel. The result would be a towline that was susceptible to extreme tension events and potential failure.

116. During the course of the tow, a strong low pressure system moved in, creating increasing seas and wind, with seas building to over 20 feet and wind 40 – 50 knots. The NANUQ's towline experienced events described as a "tightline", where the towline would lose all catenary effects and come out of the water in response to the KULLUK losing all forward motion and stopping suddenly in the seas. It was the unusual towing characteristics of the conically shaped KULLUK in response to the severe storm conditions that would create these extreme tension situations that would eventually result in the failure of the NANUQ's towline.

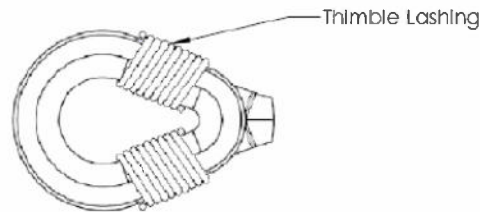
### **KULLUK Emergency Towline Failure**

117. The AIVIQ's towing hardware failed on three separate occasions during the casualty. The first was the failure of the main towing apex shackle on December 27. The second was the failure of the emergency towline on December 29. The third was the failure of the 3 inch pennant wire on December 31.

118. The failure of the apex shackle was discussed previously in the analysis. The emergency towline was a capable 400 foot line, possessing a breaking strength of over 400 tons. Testimony indicates that the AIVIQ attempted to maintain a lower tension on the line during the course of the tow, and Towcon data retrieved for the time period indicate that the tension never reached 300 tons during usage of the line. The failure occurred at the AIVIQ side of the towline at the eye end of the emergency towline. Codura® chaff protection was provided in the area of the eyes in the end of the towline consisting of the abrasion resistant material around the line itself and a steel thimble held in place with lashings as detailed in the illustration below.

---

<sup>120</sup> Crowley Marine Services Tow Wire Test Report Form, dated 5/8/13.



**Figure 74:** Diagram of the end of the emergency towline with Codura® abrasion protection and metal thimble lashed into place (*Courtesy of the Sampson Rope Technologies, Inc.*)



**Figure 75:** Photo of recovered emergency towline (eye on the KULLUK end of the emergency towline) showing missing thimble lashings allowing towline to separate from hard thimble. Blue Cordura® protection is also damaged. (*USCG Photo*)

119. The photo above depicts the condition of the eye of the emergency towline that was connected to the KULLUK side of the emergency towline. Following the failure of the eye, the ALERT was able to connect to the line and tow the KULLUK until the line was released prior to the grounding. The photo above depicts the condition of the eye following several days of abuse as the line hung into the water from the KULLUK as it remained aground.

120. While the end of the line that failed was not recovered following the casualty, it is suspected that the thimble may have been subjected to abrasive damage against the seabed for a period of over 12 hours as the AIVIQ experienced engineering casualties. Another possibility is that the lashings failed due to abrasion on the connecting shackle. During this time period, the AIVIQ was not able to provide constant tension on the line, allowing it to slacken considerably under little tension and then tighten as the drift rates between the two vessels varied. The KULLUK also passed over shallow water during this period. In Figure 75 above, the thimble lashings and portions of the Cordura® chaffing protection were worn through against the hull of the KULLUK following the grounding event and subsequent to salvage.

### **KULLUK Pennant Wire Failure**

121. On December 29, the AIVIQ successfully connected their towline to the #8 mooring/anchor wire on the KULLUK, this was a 3 ½ inch wire. The weakness of this arrangement is that while making the connection, the AIVIQ utilized their 3 inch pennant wire to connect to the KULLUK’s mooring wire. The pennant wire, from the original towing configuration, was the weak link in terms of overall breaking strength and had been subjected to extreme strain, as documented earlier in this report. During the afternoon hours of December 31, while in tow of the KULLUK with the AIVIQ, weather increased and resulted in both vessels being unable to make way against the increasing weather. The 3 inch pennant wire failed during this period.

122. Following the casualty, a 40 foot pennant wire of the same size and mill run of the original utilized in the tow was subjected to tensile tests at the Holloway Houston testing facility. Testing revealed that the line possessed a breaking load greater than the nominal breaking load expected. The history of this wire, being subjected to excessive strain during the course of the AIVIQ’s towing evolution in which the 120 ton shackle failed, along with the fact that the wire was newly purchased and installed in July of 2012, suggests that this line failed due to repeated strain and shock loading.

**ALERT**

123. Of all the vessels responding to the KULLUK, the ALERT was the most capable in terms of both bollard pull and towing equipment onboard. The ALERT responded having been released from duties as an escort vessel for oil tankers transiting to and from the Port of Valdez. The Z-Drive propulsion system allows for propeller immersion in almost all sea conditions. The ALERT’s towing package consisted of 250 feet of nylon grommet, which acts as a shock absorber to reduce extreme towline tensions. In the end, the bollard pull of the ALERT could not overcome the wind and sea effects of the KULLUK, resulting in the ALERT being pulled backward in Beaufort Force 10 storm conditions. This would eventually lead to the order to release her towline and was one of the contributing factors to the subsequent grounding of the KULLUK. The table below demonstrates the bollard pull deficiencies experienced by the ALERT during the extreme weather immediately prior to the grounding.

Weather Experienced	Alert Bollard Pull	Total forces acting on KULLUK	Deficiency
55 knot winds/ 25 foot seas	150	~225 tons/ Per 2010 study <sup>121</sup>	75 tons
55 knot winds/ 25 foot seas	150	~320 tons/ per 2013 study	170 tons

**Figure 76:** Table showing effect of weather versus Alert bollard pull when towing the KULLUK (*USCG Developed*)

<sup>121</sup> Resistance calculations will be low as the maximum values included in resistance table are 7 meter seas and 49 knot winds.



## CONCLUSIONS

1. The positive identification of the apex towing shackle that failed on December 27, 2012 cannot be determined. By all accounts, the shackle appeared to be a 120 ton Green Pin® Super Shackle manufactured by Van Beest. The exact cause of the failure or loss of the shackle cannot be determined. It can be attributed to the failure of the shackle securing cotter pin and bolt securing that device or due to the actual failure of the shackle due to defect or fatigue.
2. The analysis of the events leading up to and including the grounding of the KULLUK has determined that the “initiating event” was the failure of the 120 ton shackle that occurred the morning of December 27, 2012. However, there were numerous and compounding preconditions that created the initiating event.<sup>122</sup>
3. The causal factors that led to this casualty are as follows:
  - a. **Environmental:** There were two primary environmental causal factors.
    - 1) Significant swells out of the southwest, the result of a passing low pressure system, preceded the initial shackle failure. This environment made towing of the KULLUK exceptionally difficult, imparting significant fluctuations in towline tensions in the hours preceding the shackle failure.
    - 2) The unique hull design and bridle configuration of the KULLUK imparted motion characteristics that tended to increase the anticipated extreme loads on towlines.
  - b. **Personnel:** There are three primary causal factors that involve crewmembers.
    - 1) In general the bridge crew was experienced in towing operations. However, they possessed less experience in Gulf of Alaska waters, particularly during the wintertime. This specific lack of experience was displayed during the towing operations on December 27, where the crew took ineffective action to reduce extremes in towline tension during a period of nearly six hours prior to shackle failure. The extreme fluctuating tensions on the towline was visible to the officers from assessment of the towline catenary as well as readings and alarms on the installed towline tension monitoring equipment. The regular loading of the towline and shackle, in excess of the documented Working Load Limits and Proof Load Limits was likely a contributing factor to the shackle failure.
    - 2) The AIVIQ Master failed to provide specific instruction to his “anchor captains” or senior officers of the watch with respect to what he expected in terms of towing operations, such as acceptable tension or towline length during the KULLUK tow.
    - 3) The AIVIQ did not have onboard towing policies, procedures or other guidance for towing operations for use by the vessel crew.
  - c. **Equipment:** There are four primary causal factors that involve the selection and usage of the towing equipment.

---

<sup>122</sup> The “Initiating Event” is the first unwanted outcome in a series of occurrences, as defined by the Coast Guard Marine Safety Manual Volume 5, COMDINST M160000.10.

- 1) When compared to the expected bollard pull requirements during the anticipated heavy weather, the 120 ton apex shackle was undersized. A complete and critical assessment of the towing gear was not conducted prior to commencement of the voyage, and the warranty surveyor merely compared the equipment to that contained in the towing plan, without questioning or assessing the compatibility with respect to the anticipated weather conditions.
  - 2) Other than a visual inspection, the apex shackle was not examined thoroughly prior to the commencement of the voyage. Additionally, the history of the shackles could not be ascertained, as they were installed without knowledge of where or how they were used prior to July of 2012. The lack of regulatory requirements or other policies to conduct such an inspection regime left the condition of the shackles to an assessment that may have missed hidden defects. The visual inspection was insufficient to determine suitability or detect hidden defects.
  - 3) Tensile and metallurgical testing of other shackles from the same batch as the failed shackle did not reveal any notable defects as a result of manufacturing or usage.
  - 4) The 90 feet of surge chain utilized in the length of the tow wire was insufficient and thus ineffective in achieving the desired catenary necessary to dampen shock loading encountered during the voyage.
4. The causal factors that existed during the AIVIQ's injector failures that affected both the main propulsion and generator machinery beginning on December 27, 2012 are as follows:
- a. **Fuel Contamination:** There are four primary causal factors that involve fuel contamination, with seawater being the likely source of injector failures.
    - 1) Water contamination and other fuel purification issues were noted in engineering logs immediately prior to the casualty.
    - 2) Subsequent tests performed on a sample of fuel loaded aboard the AIVIQ at the Delta Western fuel loading facility on December 21, 2012, revealed no indication of water or seawater contamination. It did, however, exhibit an unusual and unexplained characteristic wherein a stable emulsion formed when the fuel was mixed with fresh water or seawater.
    - 3) Tests performed after the casualty indicate seawater was present in the settling tanks, #1 day tanks, main engine primary filters, and main engine injectors.
    - 4) Extensive corrosion was found on the main engine and generator injector internal parts. This corrosion contributed to a failure of the injectors of the main engines.
  - b. **Vessel Design:** There are four primary causal factors that relate to vessel design.
    - 1) The common vent and overflow system (which included the overflow tank) aboard the AIVIQ allowed for the potential for seawater contamination of the fuel system. A common header system that connected to many of the fuel tanks, including settling and day tanks could be infiltrated by seawater through vents located approximately three feet off the deck in the safety deck areas. Once the fuel oil overflow tank was full, any further seawater entering the vent/overflow system could

collect in the common fuel oil headers, where it would potentially contaminate fuel oil tanks.

2) The height and location of the fuel oil header/ overflow vents exposed them to immersion in water, which is strongly suspected to have occurred on numerous occasions prior to the loss of the AIVIQ's engines. The AIVIQ Master's request to raise the tank vents prior to commencing the voyage to Edison Chouest management was not acted upon prior to departure. The AIVIQ Chief Engineer also recommended addressing fuel tank vent issues on December 25, during the voyage and prior to engine failures.

3) When in heavy seas and towing, the AIVIQ's design allowed substantial seawater to come aboard the aft working deck and safe deck areas. Recorded CCTV coverage shows water intrusion into the safe deck areas in the hours following the failure of the apex shackle while the KULLUK was under tow utilizing the emergency towline.

4) The fuel oil purifier piping arrangement provided no effective means for responding to fuel oil day tank contamination, as it lacked the ability to recirculate and purify fuel oil in the day tanks.

c. **Fuel Management:** There are three primary causal factors that relate to fuel management onboard the AIVIQ.

1) The AIVIQ engineering personnel did not utilize the redundant fuel management systems aboard the AIVIQ to protect the critical fuel system from contamination. Protective fuel oil system configurations, designed to segregate all engines and generators in approved guidance (FMEAs) was not followed. Additionally, no formal fuel management procedures were onboard the AIVIQ for crew use and reference.

2) The practice of the crew monitoring the filter differential pressure was an ineffective means to detect water.

3) Evidence suggests the fuel oil/ overflow tank was full prior to the loss of the main propulsion engines. Failure to pump down the fuel oil/ overflow tank prior to the casualty created a situation that would allow for the contamination of the common header and fuel oil tanks.

5. The causal factors that existed during the planning, execution and response that ultimately resulted in the grounding of the KULLUK are as follows:

a. **Towing Plan:** The Shell Towing Plan(s) were not adequate for the winter towing operation crossing the Gulf of Alaska. The plan was not adequately reviewed, did not address the role of the AIVIQ Master and lacked the proper contingency planning. Errors found in the plan, particularly with respect to towing equipment, led to the misidentification of shackles by 3<sup>rd</sup> party warranty surveyors providing oversight of the operation.

b. **Re-establishing Tow:** Following failure of the apex shackle, it would have been preferable to re-establish tow with the KULLUK by reconnecting the main towline to the towing bridle. The heavy seas coupled with the fact that the cranes were not safe to use in such conditions prompted the decision to connect utilizing the emergency synthetic towline.

- c. **Evacuation of the KULLUK:** The decision to evacuate the KULLUK was made to protect life. The effect of this decision was to reduce the opportunity for other potential actions such as rigging towing gear or deploying the emergency anchor later on during the response efforts. These actions might have influenced the outcome of this casualty.
- d. **Extreme Weather Conditions:** The weather created conditions where the combined efforts of one or more towing vessels could not overcome the environmental forces acting on the KULLUK resulting in their failure to control its movement. This resulted in the failure of towing lines and equipment. At times all vessels were underpowered to control the KULLUK's movement. The weather in this case had a constant negative impact during the course of this casualty. No less than four significant low pressure systems created hazardous sea and wind conditions, particularly during the response efforts. The storms encountered were extreme, and the frequency added to the complications as there was inadequate time between storms to move the KULLUK to a safe harbor.
- e. **Response Vessel Inadequacies:** The response vessels utilized in this case were not identified in any contingency planning prior to the commencement of this voyage. The response vessels design, bollard pull and towing equipment were not sufficient for the mission at hand. Each response vessel's crew displayed skill and determination in an attempt to assist the AIVIQ and KULLUK during the course of the response.
- f. **Reliance on Single Towing Vessel:** While tows of vessels such as the KULLUK may be successfully completed utilizing a sufficiently sized towing vessel, the severe weather anticipated should have necessitated additional assets towing to share bollard pull requirements and to provide redundant towing points for the eventuality of mechanical breakdown or towline failure. Reliance on previous bollard pull requirement for towing the KULLUK was inappropriate for this voyage and weather conditions as expressed in the Metocean study for that time period.
- g. **Reliance on the AIVIQ:** The AIVIQ had a number of mechanical issues and design deficiencies which should have precluded its selection as the single towing vessel for the KULLUK on this departure date. The tow plan relied on a single towing vessel for this critical towing operation. There was no thorough assessment of the performance, operational history, mechanical and physical condition and finally the competence of the personnel of the AIVIQ to determine if that vessel was suitable for that role.
- h. **Route Taken:** The selection of a near coastal route provided inadequate sea room to allow time for response actions to take place before being set onto Albatross Bank and into the more dangerous shallower waters. Had a route been taken that was further offshore, it would have allowed more time for response assets to arrive and provided an opportunity to simply ride out the passing low pressure systems and seek safe harbor once a suitable weather window presented itself. Due to the slow transit speeds of the tow, safe harbors that were identified in the towing plan would have been difficult to utilize using the coastal route selected.
- i. **Determination of Risk:** Despite the severe weather anticipated along the route, tow planners did not recognize the overall risks involved prior to commencement of the tow. As such, no formalized risk assessment was conducted and no additional scrutiny was paid to previous towing operations of the KULLUK. The original risk determinations, made prior to the KULLUK departing Seattle for the 2012 drilling

season, were considered to remain valid and therefore were not questioned. The lack of written policies for tow planning and execution contributed to this event.

6. During the course of the investigation the use of cell phone and other wireless devices was examined and found not to be a contributing factor to the casualty.

7. There is no evidence that the use of dangerous drugs or alcohol contributed to this casualty. Due to the nature of this casualty drug and alcohol testing was not required by regulation. Offshore vessel personnel involved in the incident were subject to periodic and random drug testing programs.

8. Fatigue, medication and sleep patterns were considered and examined. This incident spanned a considerable period of time from the tow's departure from Dutch Harbor to the grounding of the KULLUK on Sitkinak Island on December 31, 2012. The AIVIQ's watch system did not comply with specific regulations for this type of voyage. Regulations require a three watch system on voyages of this type and purpose that extend over 600 miles. The twelve hour watch system most likely contributed to fatigue among the vessels licensed personnel on the bridge and in the engine room. The severe sea conditions that were encountered in themselves induced fatigue in personnel. The effects of fatigue could not be definitely determined but cannot be discounted. Testimony indicated that during the time period after the towing gear failure on December 27, vessel personnel aboard the AIVIQ vessels claim to have taken steps to minimize and mitigate the effects of fatigue during the emergency phase of operations.

9. There is no evidence that any act of misconduct, incompetence, negligence, lack of professionalism, and/or willful violation of law committed by any officer, employee, or member of the Coast Guard contributed to this casualty.

## **SAFETY RECOMMENDATIONS**

In the interests of reducing the possibility of the occurrence of similar events the following safety recommendations are submitted as part of this report.

### **Commandant of the Coast Guard:**

1. It is recommended that the Commandant partner with the Towing Safety Advisory Council (TSAC) to establish a working group to draft and accept a Task Statement addressing, but not limited to the issues raised by this marine casualty, the towage of MODU's in the arctic marine environment and the following:
  - a. The study and prescribed standards for ocean tows of MODU's to include inspection non-destructive testing of towing equipment prior to tows.
  - b. The process of issuing and tracking certificates that accompany towing hardware to include identifying a particular component by a standardized tracking method.
  - c. A detailed review of towing configurations and tow escorts for MODU ocean tows and development of tow plans in most effective manner.
  - d. Evaluate the practice of logging ocean towing operations for MODU's or vessels of a similar nature. Determine the effectiveness of a log being kept detailing the history of each item of the towing equipment utilized for the MODU tow. This includes shackles, towing plates, connector links, bridge chains, pendant wires and other towing connections.

- e. Evaluate usage and application of strain monitoring devices equipped on towing vessels to determine the recommended procedures to reduce the likelihood of towing equipment failures.

**Coast Guard District 17:**

2. In recognition of the unique Arctic environment and growing oil and gas production activities, Coast Guard District 17 (D17) in consultation with entities operating MODU's or similar large non self-propelled vessels and the State of Alaska, should develop minimal criteria for ocean tows within the D17 area of responsibility. This criteria should include considerations for:
  - a. Tow Routing
  - b. Suitability of towing vessels, including an emphasis on installation and usage of tow strain monitoring equipment, bollard pull capabilities taking into account expected environmental conditions, and availability of towing procedures and policies tailored to each individual tow
  - c. Contingency planning including harbors of safe refuge
  - d. Towing equipment sized and configured for anticipated environmental forces
  - e. Acceptable 3<sup>rd</sup> Party assessments of operations prior to tows, scope to include all aspects of towage
  - f. Considerations for tow plan review by regulatory agencies including the State of Alaska and local COTP
3. It is recommended that Coast Guard District 17 evaluate the existing towing equipment aboard its medium and high endurance cutter and icebreaker fleet to determine its existing towing practices and equipment capabilities. Upon conclusion of this assessment the District should evaluate the equipment to determine if the fleet can upgrade towing capabilities and equipment for USCG vessels that will operate in the 17<sup>th</sup> Coast Guard District.

**Shell and any Corporation or Entity Intending to Work in the Arctic Marine Environment:**

4. Develop and maintain policies and guidance that addresses all aspects of marine operations to include tow planning for operations across the globe, and establish additional criteria for operations that take place in areas of historical heavy weather, such as the Alaskan theatre. Shell should consider criteria for:
  - a. Tow Routing
  - b. Suitability of towing vessels, including an emphasis on installation and usage of tow strain monitoring equipment, bollard pull capabilities taking into account expected environmental conditions, and availability of towing procedures and policies tailored to each individual tow
  - c. Contingency planning including harbors of safe refuge
  - d. Towing equipment sized and configured for anticipated environmental forces
  - e. Acceptable 3<sup>rd</sup> Party assessments of operations prior to tows, scope to include all aspects of towage

**Edison Chouest Offshore or any Marine Company Intending to Work in the Arctic Regions:**

5. ECO should reevaluate operating procedures for vessels operating in the Gulf of Alaska or similar environments, specifically to ensure that they develop towing procedures, policies,

guidelines, checklists and job safety aids for towing operations that would be conducted by vessels in its fleet. These procedures should include the full use of the capabilities of strain monitoring devices if installed. These towing procedures should be included in the Safety Management System (SMS) for ECO vessels.

6. ECO should ensure critical fuel oil management and towing procedures are developed and included in the Safety Management System (SMS) for the AIVIQ.
7. ECO should establish levels of competencies and formal training requirements for Masters and Mates engaged in towing. This may involve the use of simulators to provide realistic training. Consideration should be given for developing a training program and syllabus at the ECO Training Center specifically for towing operations.
8. Working with the Coast Guard and ABS, ECO should address all potential design engineering deficiencies noted in this report, particularly those items addressed in the Coast Guard Marine Safety Center analysis included as Appendix 1.

## **ENFORCEMENT**

### **Civil Penalty**

1. This investigation has determined that there is sufficient evidence that a violation of law or regulation may have occurred on the part of Edison Chouest Offshore (ECO) in that they failed to report the numerous marine casualties and safety related vessel issues contained in Findings of Fact (53 & 54) and Analysis (83 – 89) sections of this report. As a potential violation of the marine casualty reporting requirements as established in 46 CFR 4.05-1, this matter should be turned over to the cognizant civil penalty authority for consideration.

### **Suspension and Revocation**

1. This investigation has determined that there is sufficient evidence that the AIVIQ Chief Engineer may have committed an act of negligence by not adhering to good marine engineering practices with regard to onboard fuel management practices aboard the AIVIQ. This matter should be turned over to the cognizant suspension and revocation authority for consideration.
2. This investigation has determined that there is sufficient evidence that the AIVIQ Master may have committed an act of negligence by not establishing sufficient effective oversight and procedures for the bridge officers aboard AIVIQ to safely tow the MODU KULLUK in the winter Gulf of Alaska environment. This matter should be turned over to the cognizant suspension and revocation authority for consideration.
3. This investigation has determined that there is sufficient evidence that a violation of law or regulation may have occurred on the part of the Master of the AIVIQ with regard to the watch keeping system in place on the AIVIQ. As a potential violation of deck and engine room watch requirements as established in 46 CFR 15.705 requiring a 3-watch schedule for voyages over 600 miles. This matter should be turned over to the cognizant authority for consideration.
4. This investigation has determined that there is sufficient evidence that the AIVIQ 3<sup>rd</sup> Mate, Mr. [REDACTED] may have committed an act of negligence by failing to ensure appropriate tension remained on the towline and associated gear during his watch immediately prior to

the shackle failure on December 27, 2012. This matter should be turned over to the cognizant suspension and revocation authority for consideration.

## COMMENDABLE ACTS

1. In response to the grounding of the MODU KULLUK, the following entities or individuals should be considered to be noted for commendable acts in the ROI.

MODU KULLUK - Crew of the MODU KULLUK under the leadership of the Offshore Installation Manager and the Tow Master for their skill and resourcefulness following the failure of the towing gear mid-morning on December 27, 2012. In rigging multiple emergencies towing systems and later preparing the rig for evacuation and eventual grounding in Oceans Bay, Alaska.

M/V AIVIQ - For the period following the failure of the towing gear mid-morning on December 27, 2012 while towing the MODU KULLUK. Recognizing the deck and engineering crew for their skill and resourcefulness in extremely challenging winter weather conditions for rigging emergency towing equipment and repairing significant engine and generator malfunctions to assist in preventing a more dire consequence for the grounding of the MODU KULLUK.

Tug GUARDSMAN – Master and crew for their skill and resourcefulness in extremely challenging winter weather conditions for rigging emergency towing equipment to assist in preventing a more dire consequence for the grounding of the MODU KULLUK.

Tug ALERT – Master and crew for their skill and resourcefulness in extremely challenging winter weather conditions for rigging emergency towing equipment to assist in preventing a more dire consequence for the grounding of the MODU KULLUK.

OSRV NANUQ - Master and crew for their skill and resourcefulness in extremely challenging winter weather conditions for rigging emergency towing equipment to assist in preventing a more dire consequence for the grounding of the MODU KULLUK.

USCGC ALEX HALEY - Crew for the response to the towline and propulsion failures that occurred on the MODU KULLUK. Attempts to tow in extreme conditions coupled with performing duties as the On Scene Commander during the incident.

Unified Command – In response to the conditions surrounding the tow of the KULLUK, Shell initiated an Incident Management Team. As the incident progressed, CG Sector Anchorage was notified that the AIVIQ had lost the tow and under the leadership and guidance of the Federal on Scene Coordinator (FOSC), a Unified Command was established in Anchorage, AK. The Unified Command was comprised of over 400 personnel including numerous federal, state and industry stakeholders. Their successful coordination resulted in the successful planning, assessment, staging and utilization of tactical resources to execute the rescue of personnel aboard the KULLUK, the salvage and movement of the MODU KULLUK, and mitigation of any potential pollution event originating from the MODU.

USCG Air Station Kodiak and Base Kodiak – Aviation crews and base support personnel. For the helicopters engaged in the parts resupply mission to the AIVIQ and the eventual safe evacuation of 18 personnel from the MODU KULLUK under harsh and extreme winter Alaskan weather conditions.



Edison Chouest Offshore LLC - Shore side support and logistics personnel for securing necessary spare parts throughout the contiguous United States and expediently delivering them to Alaska to return the IAHTS AIVIQ to full propulsion capability during the response to the towing gear failure.

Appendix (1) Marine Safety Center Analysis of M/V AIVIQ Marine Casualty

## **Appendix 1**

### Marine Safety Center Analysis of M/V AIVIQ Marine Casualty

(Blank)



16710/P018033/  
Serial E2-1304100  
26 Nov 2013

## MEMORANDUM

From: J. P. NADEAU, CAPT  
CG MSC

Reply to  
Attn of: Mr. [REDACTED]

To: J. D. MCTAGGART, CDR  
Investigations National Center of Expertise

Subj: REQUEST FOR ASSISTANCE WITH MODU KULLUK INVESTIGATION

Ref: (a) Your memo 16731 of 8 Jul 2013

1. In reference (a), you requested Marine Safety Center review and comment of various aspects of the design and operation of the M/V AIVIQ related to events surrounding the loss of main propulsion on 28 Dec 2012.
2. Results of our review are summarized in enclosure (1). In general, our analysis indicates:
  - a. AIVIQ's loss of main propulsion engines was likely due to fuel contamination by seawater.
  - b. Certain aspects of AIVIQ's engineering design may not comply with the intent of classification and/or regulatory standards. At a minimum, certain aspects of the design did not represent good marine practice, and likely reduced the crew's ability to prevent, detect, and respond to fuel contamination when it did occur.
  - c. Certain vessel fuel management practices further contributed to the casualty.
3. If you have any questions concerning this report, please feel free to contact Mr. [REDACTED] at (703) 872-6771.

#

Encl: (1) Marine Safety Center Analysis of M/V AIVIQ Marine Casualty

## **1. Introduction**

- A. IAHTS AIVIQ experienced a total loss of main propulsion engines on 12/28/2012. At the request of the Coast Guard Investigating Officer for this reportable marine casualty, the Marine Safety Center has reviewed relevant documentary evidence. MSC observations are detailed below. In brief, we believe:
- (1) AIVIQ's loss of main propulsion engines was likely due to fuel contamination by seawater.
  - (2) Certain aspects of AIVIQ's engineering design do not appear to comply with the intent of classification and/or regulatory standards. At minimum, in our opinion, these aspects of the design did not represent good marine practice, and likely reduced the crew's ability to prevent, detect and respond to fuel contamination when it did occur.
  - (3) Certain on board fuel management practices further contributed to the casualty.
- B. The AIVIQ is an Ice Anchor Handling Tug Supply Vessel (IAHTS) built by North American Shipbuilding. The vessel is classed by the American Bureau of Shipping (ABS). ABS Class Notations include Automatic Centralized Control Unmanned (ACCU) and Dynamic Positioning System (DPS-2). The DPS-2 design is based on the 2011 ABS "Rules for Building and Classing Steel Vessels." The vessel's fuel oil (FO) system was designed to meet 2009 ABS "Rules for Building and Classing Steel Vessels" and the "U.S. Supplement to ABS Rules for Steel Vessels Certificated For International Voyages," 1 June 2009, in accordance with the U.S. Coast Guard NVIC 2-95, Change 2, the U.S. Coast Guard Alternative Compliance Program (ACP).
- C. References noted below are listed on page 20 of this Enclosure.

## **2. Observations**

- A. Main Engine and Ship Service Diesel Generator Engine Injector Failures
- (1) Available evidence suggests that failure of main engine and ship service diesel generator engine injectors can be attributed to seawater contamination of fuel oil. AIVIQ took on fuel oil on 12/21/2012 from Delta Western. Subsequent analysis of a sample of fuel loaded on board the vessel indicate that it met specifications.
    - (a) During bunkering of the AIVIQ at Delta Western, fuel oil samples were taken at various points during the transfer, including at the start (<1000 gallons), 200,000 gallons, 300,000 gallons, and 400,000 gallons. References (a) and (b), indicate that a sample from the first 1000 gallons of fuel oil loaded on AIVIQ at Delta Western met specifications, was free of water, and that laboratory analysis found no contamination.
      - i. While the fuel oil met specifications, reference (a) identified that during bacteria testing, when the fuel oil was mixed with water and shaken, a stable emulsion was formed between the oil phase and the water phase.

The formation of a stable emulsion is not normal. The nature of this substance was not determined by testing performed at the lab.

ii. We note in reference (c), the Chief Engineer identified that a clear-yellowish gel was found in some of the fuel oil samples taken from the vessel after the casualty.

(b) The Ultra Low Sulfur Diesel used to bunker AIVIQ at Delta Western was provided by the tanker AFFINITY. The AFFINITY was loaded in Japan in June 2012. Reference (d) shows that the fuel oil met all specifications with the exception of conductivity (30 pS/m). Stadis 450 was added to the fuel oil loaded aboard the AFFINITY to bring the conductivity up to specification. Conductivity is required to be 200-1000 pS/m (ASTM D2624) to prevent the generation of static charges.

(2) Review of the engineroom logs, references (e) and (f), indicates that:

(a) Prior to the casualty, there were problems with Main Engine and Ship Service Diesel Generator fuel injectors.

i. 09/06/2012: Ship Service Diesel Generator No. 2 -- replaced injectors #1, #3, #5, #7, #11.

ii. 09/08/2012: Ship Service Diesel Generator No. 2 -- replaced injector #9.

iii. 09/29/2012: Ship Service Diesel Generator No. 2 -- replaced injector #9.

iv. 10/03/2012: Ship Service Diesel Generator No. 2 -- injectors #6 and #12 found to have bad o-rings.

v. 10/08/2012: Ship Service Diesel Generator No. 5 -- injector #12 leaking.

vi. 10/09/2012: Ship Service Diesel Generator No. 5 -- replaced injectors #7, #12.

vii. 10/10/2012: Ship Service Diesel Generator No. 2 -- replaced injector #12.

viii. 10/25/2012: Ship Service Diesel Generator No. 2 -- replaced injectors #2, #4, #6, #8, #10.

ix. 12/12/2012: Main Engine No. 3 -- replaced injector #8.

(b) Prior to the main engine failures, there were problems with fuel quality.

i. Log entries for clogged fuel oil flowmeters indicate problems with the fuel oil quality (e.g., contamination). Reference (g) shows Main Engines and Ship Service Diesel Generators have supply and return Kral screw type flowmeters installed to monitor fuel consumption. Log entries show recurring problems with supply and return Kral flowmeters becoming clogged. The Kral supply flowmeters are upstream of the engine filters. Kral return flowmeters are downstream of the primary Racor filters and

engine secondary filters. The following problems with Main Engine and Ship Service Diesel Generator fuel oil Kral flowmeters were logged:

- 05/07/2012: Cleaned FO Strainer to No. 1 Main Engine due to FO meter not working.
  - 05/08/2012: Troubleshoot Main Engine No. 1 Supply Kral Meter.
  - 06/29/2012: Disassemble Main Engine No. 4 Supply Kral Meter (full of plastic).
  - 07/14/2012: Pulled Kral Meter from Main Engine No. 1.
  - 07/31/2012: Disassembled Fuel Meter from Main Engine No. 3, removed debris.
  - 08/04/2012: Cleaned TFO Boiler supply and return flowmeters.
  - 08/05/2012: Bypass Main Engine No. 3 Kral meter for service/cleaning.
  - 08/14/2012: Removed and cleaned Main Engine No. 3 Kral meter.
  - 08/17/2012: Remove and clean Main Engine No. 1 Kral flow meter.
  - 08/31/2012: Main Engine No. 3 Supply Kral meter fouled.
  - 09/13/2012: Pulled and cleaned Main Engine No. 1 Return Kral meter.
  - 09/25/2012: Replaced return Kral meter bearings on SSDG No. 3.
  - 11/03/2012: Kral meter plugged on Main Engine No. 2
  - 12/21/2012: Main Engine No. 3 Return Kral meter failed, bypassed and cleaned.
  - 12/23/2012: Troubleshoot Main Engine No. 2 Kral supply meter.
- ii. At 1000 on 12/27/2012, Settling Tanks Port/Stbd and No. 1 Day Tanks Port/Stbd were “Color Cut”, and logged as “All OK”. Kolor Kut is a water finding paste used on sounding tapes for gauging the amount of water in tanks. We note, however, that reference (h) shows no settling tank sounding tubes.
- iii. The engineroom logs indicate that the “tow wire broke” at 1135.
- iv. Later in the day (the times of some rough log entries are not legible), on 12/27/2012, prior to loss of any main engines, the crew secured the Port Aft Fuel Oil Purifier because it “was processing less than 7 gpm after all the water.” At that time, they placed the Port Forward Fuel Oil Purifier on line. Reference (g) shows each purifier has a rated capacity of 3,900 liters per hour (~17 gpm).
- v. The smooth log (only) indicates “traces of water” were found in the Settling Tanks and No. 1 Day Tanks. It is not clear how the traces of water were detected.
- (c) The loss of main engines started at 2253 on 12/27/2012 when Main Engine No. 2 was shut down and could not be restarted. Log entries show fuel injectors failing on all main engines. Main Engines No. 3 and No. 4 failed at 0145 on 12/28/2012, followed by the failure of Main Engine No. 1 at 0245.

- (d) On 12/29/2012 Ship Service Diesel Generator fuel injectors began to rapidly fail, starting with Ship Service Diesel Generator No. 5. “Small amounts of water and small amounts of slime” were found in Ship Service Diesel Generator No. 2 primary fuel oil Racor filters and “small amounts of slime” in secondary fuel oil filters on 01/01/2013. All Ship Service Diesel Generator fuel injectors were replaced following the incident.
- (3) Analysis of fuel oil and main engine filter samples collected after the casualty indicate seawater contamination.
- (a) Fuel oil samples taken from No. 1 Day Tanks Port/Stbd on 12/28/2012 were tested. In references (i) and (j), DNV Petroleum Services found 0.5% water (by volume) in No. 1 Day Tank Port and sodium and magnesium in both No. 1 Day Tanks (Port/Stbd). The combination of sodium and magnesium in the samples indicates that the fuel oil was contaminated with seawater. Some biological growth was noted in both samples.
  - (b) Caterpillar (CAT) fuel specifications provided in reference (k) limit water and sediment content of diesel fuel to a maximum of 0.05%. The amount of water measured in the sample from No. 1 Day Tank Port was ten times greater than the maximum allowable amount specified by the manufacturer.
  - (c) In references (l) and (m), both free water and sediment were found in samples taken on 01/16/2013 (see reference (n)) from the Port and Starboard Settling Tanks. Measureable quantities of water were found in samples taken from No. 1 Day Tanks Port (255 mg/kg) and Stbd (125 mg/kg). Major constituents of seawater (NaCl, Na, Cl, Ca, Mg) were found on main engine filter elements and main engine injector internal components. Reference (m) states that main engine filter elements had what appeared to be biological contamination.
- (4) Extensive corrosion was observed on injectors examined by Southwest Research Institute (SWRI) and CAT. The extent of corrosion may be an indication that at least some level of contamination of fuel oil with water and/or seawater was ongoing and may not have occurred over a period of just a few days.
- (a) In reference (o), SWRI performed a forensic analysis of one main engine injector and one ship service diesel generator injector to determine the cause of the failures. Inspection of the main engine injector (CL13-4757) identified that excessive corrosion resulted in the injector check valve (pintle) becoming seized in the injector tip (nozzle assembly), making the injector inoperative. Excessive corrosion was found on injector internal components, as well as evidence of internal fuel leakage due to corrosion. Inspection of the ship service diesel generator injector (CL13-4756) also found excessive internal corrosion. The corrosion on this injector was “very loose and easily knocked off the internal injector components”. Reference (o) concluded that excessive corrosion and deposits found on internal components were likely to interfere with the injector’s timing and proper fuel atomization.



- (b) In reference (p) Caterpillar performed a forensic analysis of representative samples of main engine injectors. Four injectors were opened and all had seized check valves (i.e., were inoperative) with heavy corrosion found on the injector internal components. Metallurgical analysis using Energy Dispersive Spectroscopy (EDS) confirmed high content of iron and oxygen (i.e., rust), and high levels of sodium, chlorine, calcium, and potassium (i.e., major constituents of seawater) on all injector internal parts. Reference (p) concluded that a high level of corrosion led to tip seizure which resulted in injector failure.
- (c) In reference (m), laboratory analysis of injector internal components found sodium chloride, sodium, chlorine, calcium, and potassium (i.e., major constituents of seawater).

B. Ability to Prevent, Detect and Respond to Fuel Oil Contamination

- (1) The common vent and overflow system aboard AIVIQ appears to have allowed seawater contamination of the main engine and ship service diesel generator fuel supplies, leading to the loss of main propulsion in rough sea conditions.
  - (a) Reference (q) shows the AIVIQ fuel oil storage tanks, settling tanks, and No. 1 and No. 2 Day Tanks (Port/Stbd) are all connected to a common vent and overflow system. Two common vent/overflow headers run fore and aft, one Port and one Starboard. Each vent/overflow header has four vents, two forward and two aft. Each vent/overflow header drains into a common FO Overflow Tank via an overflow alarm sensor arrangement. Vent/overflow piping from each fuel oil tank connects to a vent/overflow header via a gooseneck. The goosenecks extend above the Main Deck to prevent sloshing fuel within tank(s) from reaching the vent/overflow header.
    - i. References (r) and (s) both define the Worst Case Failure (WCF) of the fuel oil system as contamination of one fuel oil day tank. However, the connections between the fuel oil storage, settling and day tanks, could result in a much more severe WCF involving simultaneous seawater contamination of multiple day tanks via the vent/overflow system.
    - ii. Reference (q) shows an overflow alarm sensor arrangement (see Figure 1). The 8-inch vent/overflow headers are each reduced to 6-inch pipe prior to reaching the overflow alarm sensor arrangement. Per references (e) and (f), the crew experienced many problems with the fuel oil vent/overflow alarm system prior to the casualty.
      - 8/06/2012: Reference (f) 0420 - Fuel oil overflow alarm went off. No fuel was being transferred except centrifuges to DTs #1S and #1P. Fuel Oil Overflow Tank is at 5% with 225 gals showing on TLI.
      - 8/06/2012: Reference (f) 0900 - Empty both Port and Stbd Overflow Alarm Pots on the F/O Alarm Piping. Both drains were clogged. Breaker #17 in EP-201 is Back Online.

- 08/25/2012: Reference (f) - Overflow alarm activated, found drain lines clogged on port side. Removed and cleaned.
  - 09/04/2012: Reference (e) - Cleaned P/S Overflow Collection Pipe Drains.
  - 11/21/2012: Reference (e) - Drained port overflow alarm system.
  - 12/26/2012: Reference (f) - Secured fuel overflow breaker ELP-201 Bkr 17.
- iii. In reference (c), the Chief Engineer acknowledged that the water on deck shown in a photograph during the interview was well above the height of the vent/overflow tank vents.

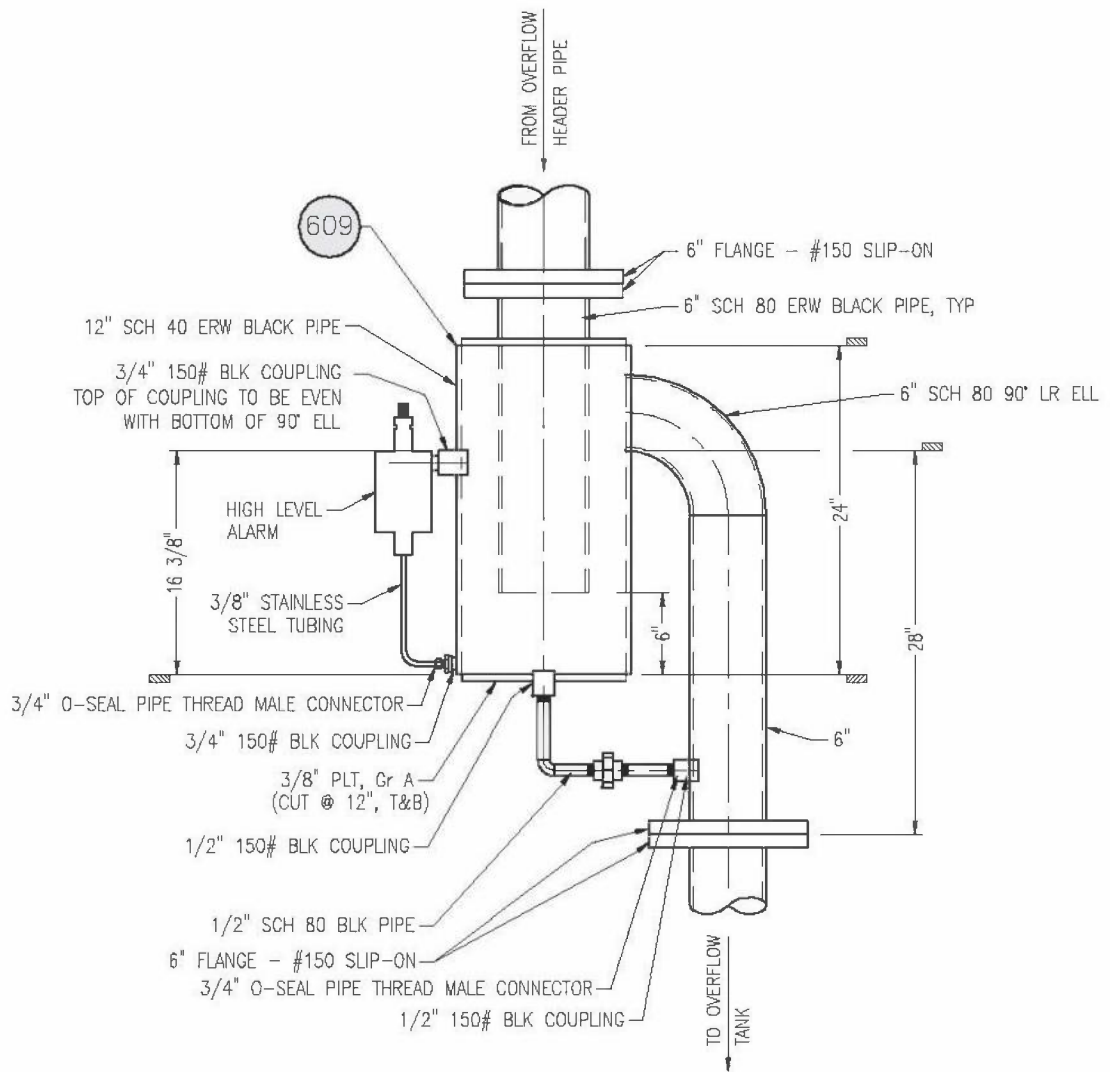


Figure 1 - Fuel Oil Overflow Alarm Sensor Arrangement (Source: reference (q))

- iv. Reference (f) shows the circuit breaker for the fuel oil vent/overflow alarm was opened during the Midnight to Noon watch on 12/26/2012. In reference (c), the Chief Engineer indicated that during rough seas, with a full load of fuel, a certain amount of fuel would overflow into the FO Overflow Tank. If seawater entered the vent and overflow system, it would cause an overflow alarm condition.
- v. Reference (t) shows rapid filling of the FO Overflow Tank from approximately 1000 gallons at 0000 on 12/27/2012, to over 4000 gallons in the early hours of 12/28/2012.
- vi. In reference (c), the Chief Engineer indicated that he understood the FO Overflow Tank was full leading up to the casualty. He stated that normally they would pump the FO Overflow Tank into the Settling Tanks, “but under the conditions that we were in, that wasn’t something we were going to do at the time.”
- vii. Reference (f) shows approximately 5000 gallons was pumped from the FO Overflow Tank to No. 2 Double-bottom FO Storage Tank on 01/03/2013. The crew sounded the tank using water gauging paste (Kolor Kut), and estimated the amount of water pumped from the FO Overflow Tank to be 1832 gallons.
- viii. Reference (u) indicates the crew notified the ECO Office on 01/03/2013 that they were suspicious of faulty “P/V valves” on deck and these were to be inspected upon arrival. In reference (c), the Chief Engineer testified that the fuel oil vents were examined and were found to be functioning normally with no damage.
- ix. Reference (e) shows that, during a previous tow on 09/17/2012 the crew marked the sight glasses of the Settling Tanks and No. 1 Day Tanks (see evidence ID K003262 of reference (e)). It is not clear why the crew would have marked the sight glasses, but it suggests that the crew may have been monitoring for flow of seawater from the vent and overflow system into the Settling Tanks and No. 1 Day Tanks.
- x. Reference (q) shows that after the incident, vents for the fuel oil vent/overflow system were raised 6-feet.
- xi. Tank vents installed on the vent and overflow system are Aero 1 check type vents manufactured by ██████████ AS. The vents use a flat circular plastic float, guided with a center pin, and a gasket to make a low leakage seal when submerged. Heater kits provided by the manufacturer were installed. The heater prevents the float from becoming frozen (e.g., to the guide pin) in low temperatures. The float must be able to move freely to make a seal when the vent becomes submerged. Icing does not appear to have impacted the operation of the vent/overflow system.

(2) MSC review of AIVIQ construction drawings and documents identified weaknesses in the design that limited the means available to the crew to detect and respond to

fuel oil contamination of the main engine and ship service diesel generator fuel supplies.

- (a) Settling tanks have inadequate means for the crew to regularly drain the tanks to check for water and/or sediment.
  - i. Reference (g) specifies the settling tanks were designed with drains installed 1-inch from the bottom of each tank and were to be provided with a swing open self-closing gate valve with cap and chain on each tank. Part 4-6-4/13.5.1(b) of reference (v) requires that, where the drainage of water from settling tanks is through valves of a self-closing type, arrangements such as gutterways or other similar means are to be provided for collecting the drainage. Reference (g) shows no means to collect the drainage.
  - ii. From reference (w), however, it appears that the settling tank drains, as installed, have a gate valve, a small ball valve, and a pipe plug (see Photo 1). As installed, there appears to be no drip pan provided as required by Part 4-6-4/13.3.4(a) of reference (v). The small ball valve installed on each of the settling tank drains, with no means for collecting drainage, appears to be inadequate for draining a large amount of water, sediment or oily discharge.



Photo 1 - Starboard Settling Tank Drain

- iii. Reference (x) identifies that, with the vessel on an even keel, a significant amount of water (approximately 170 gallons) would have to accumulate in the settling tanks before reaching the tank drains. Further, reference (g)

identifies that each settling tank is provided with one purifier suction installed 12-inches from the bottom of the tank. If undetected before reaching the purifier suction, about 2000 gallons of water could accumulate in the tank.

- iv. References (h), (x) and (y) identify that the settling tanks are each 34' long, 8' wide, and 10' deep. The flat bottoms of the settling tanks, coupled with their long, shallow geometry make decanting water, sludge or sediment difficult.
- (b) There are inadequate means provided for the crew to remove any accumulated water or sediment from the day tanks before it may be drawn into the engines.
- i. Reference (g) shows the day tank drains and the day tank suctions supplying fuel oil to the main engines and ship service diesel generators are all located 1-inch from the bottom of the day tank. Reference (z) recommends that engine fuel supply suctions be located near the bottom of the fuel tank, but not so low as to pick up collected water or sediment.
  - ii. References (h) and (y) show that the day tank bottoms are partially sloped inboard, a good geometry for drainage of water and sediment. Review of references (h), (x), and (y) indicate that day tank drain valves are installed approximately 4 feet higher than the tank bottom, with a 48 inch tailpipe that extends to a point 1 inch from the tank bottom. Due to the fluid retained in the 48-inch tailpipe, approximately one quart of drainage would be necessary before providing an accurate sample from the tank bottom.
  - iii. From reference (w), it appears the day tank drains have a gate valve, a small ball valve, and a pipe plug (see Photo 2). There appears to be no drip pan provided as required by Part 4-6-4/13.3.4(a) of reference (v). The small ball valve installed limits the ability to effectively decant water or sediment from the bottom of the day tanks.
- (c) While in compliance with applicable standards, the fuel oil purifier arrangements provide no practical means to effectively respond to fuel oil contamination in the day tanks.
- i. Four fuel oil purifiers are installed, two port and two starboard (see Figure 2). One electric fuel oil heater is provided for each purifier pair. Fuel would be purified during transfer from the settling tanks to the day tanks. We note that the fuel oil system aboard AIVIQ lacks the ability to purify fuel oil in any of the day tanks via recirculation. While this is not required by reference (v), it is encouraged by the engine manufacturer in Figure 9 of reference (z), which shows a typical purifier installation and includes provisions for recirculating fuel oil in the day tank. It appears that the only means on board AIVIQ to purify oil in a day tank is to fill it until the fluid level reaches the overflow piping. Reference (g) shows overflow piping installed 3-inches from the top of each of the day tanks. These



Photo 2 - No. 1 Day Tank Stbd Drain

overflows are independent of the connections from the tops of the day tanks to the fuel oil vent/overflow system.

- Reference (g) shows No. 1 Day Tanks overflow into their respective adjacent settling tanks via non-return valves. Since these connections are at the top of the tanks, they would not effectively remove any water or sediment from the day tanks.
  - Reference (g) shows No. 2 Day Tanks overflow into No. 1 Day Tanks via non-return valves. It is unclear what the purpose of these connections are, but it should have been considered in references (r) and (s) since these connections serve as a source of cross-contamination between No. 2 Day Tanks and No. 1 Day Tanks. It is also unclear how this arrangement was intended to function, since the tops of No. 2 Day Tanks are 24'-0" above the Baseline and the tops of No. 1 Day Tanks are 34'-0" above Baseline. The tops of the Settling Tanks are also 34'-0" above Baseline.
- ii. Each purifier pair is equipped with an EHS-161 electric fuel oil heater. From reference (aa), this heater is capable of raising the temperature of fuel oil approximately 12°C at the maximum rated output of the purifier. From reference (bb), fuel oil should enter the purifier at an inlet

temperature of 40°C. It follows that fuel oil should be at a temperature of at least 28°C at the inlet to the fuel oil heater in order for the purifier to achieve maximum rated output.

- References (e), (f), and (cc) show frequent purifier alarms and “purifier troubleshooting” on the day of the casualty.
- As noted earlier, reference (f) shows on 12/27/2012 that the Port Aft purifier was operating well below rated capacity (7 GPM vs. 17 GPM).
- The reduced purifier output and frequent alarms are consistent with water contamination, as water in the fuel oil would have required more energy to heat, and led to recirculation through the purifier heater, reducing purifier output.

- (3) Design weaknesses in the Main Engine Primary Fuel Oil Filter installation contributed to main engine injector failures.
- (a) Part 4-6-5/3.3.4 of reference (v) requires filters in the main engine fuel oil injection-pump suction lines to be arranged such that they can be cleaned without interrupting the fuel supply. This can be achieved through use of two filters in parallel, or use of a duplex type filter with a changeover facility.
  - (b) Reference (g) identifies that each main engine is provided with a single Racor RVFS-1 fuel oil filter. The RVFS-1 filter has a flow rate of 1500 gallons per hour using the OCP-15868 10 micron coalescer and SP-15405 10 micron separator filter elements specified in the referenced drawing. Reference (dd) identifies main engine maximum fuel consumption is 261.9 gallons per hour. While these filters are of sufficient capacity, they provide no redundancy. Without redundant fuel oil primary filters, the crew would either have to bypass the filters or shut down the main engine to service the filters.
  - (c) Reference (g) shows a 0-100 psig pressure gauge installed on the discharge side of the filter vice a differential pressure gauge. This will provide filter outlet absolute pressure, not filter differential pressure.
  - (d) Reference (g) identifies that sight glasses and water monitoring probes available for the main engine RVFS-1 filters were not installed. If present, sight glasses permit checking for accumulated water; water monitoring probes are used to activate an alarm if water is detected in the filter body.
  - (e) USCG inspection of the RVFS-1 filter drains identified they were incorrectly installed in the bottom sight glass port of the filters instead of the drain port provided (see Photo 3 and reference (ee)). Reference (ff) indicates this will result in water always being present in the bottom of the filter (i.e., between the lower sight glass port and the drain port).

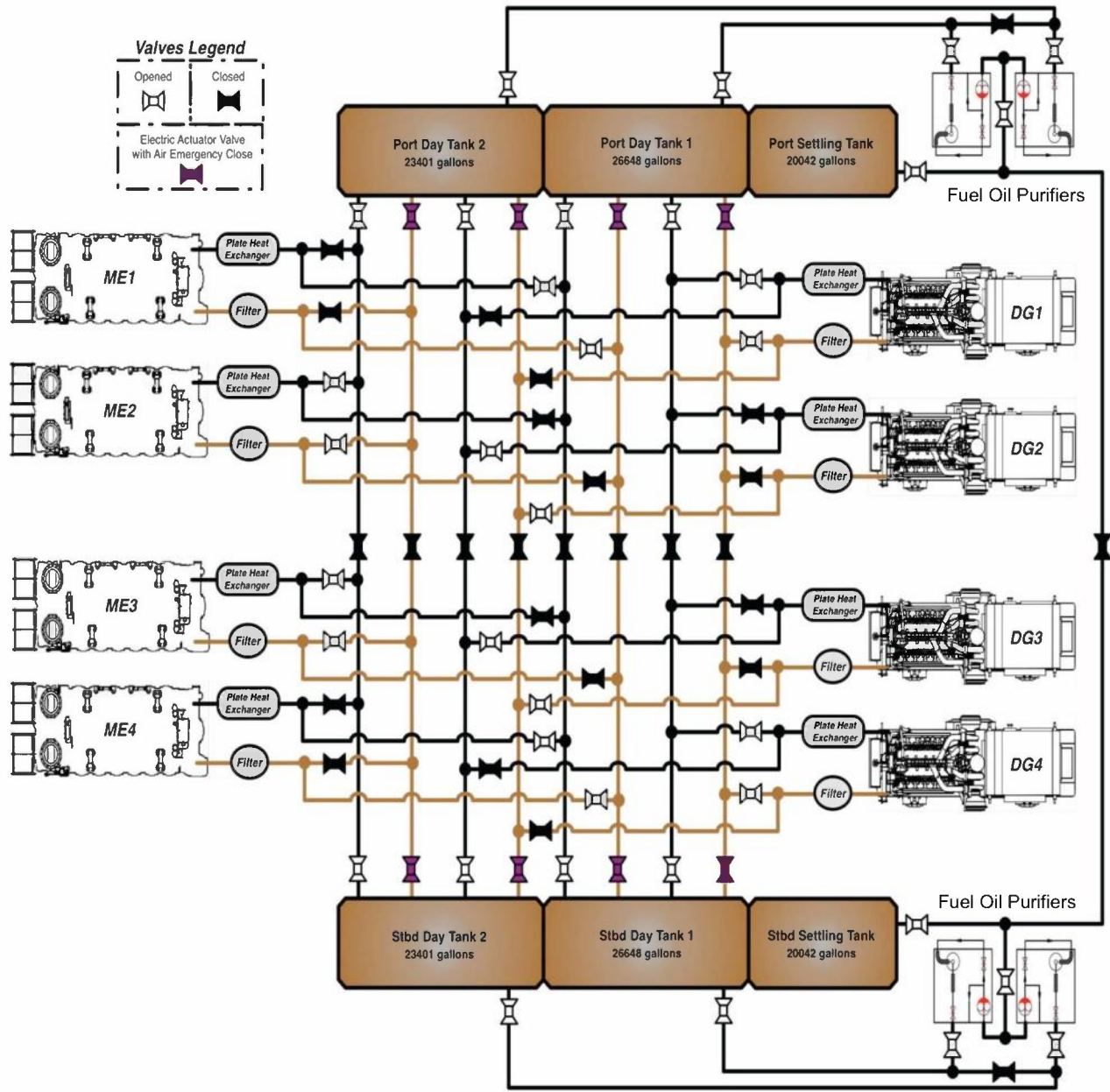


Figure 2 - AIVIQ FO Service System Diagram (Source: reference (s))



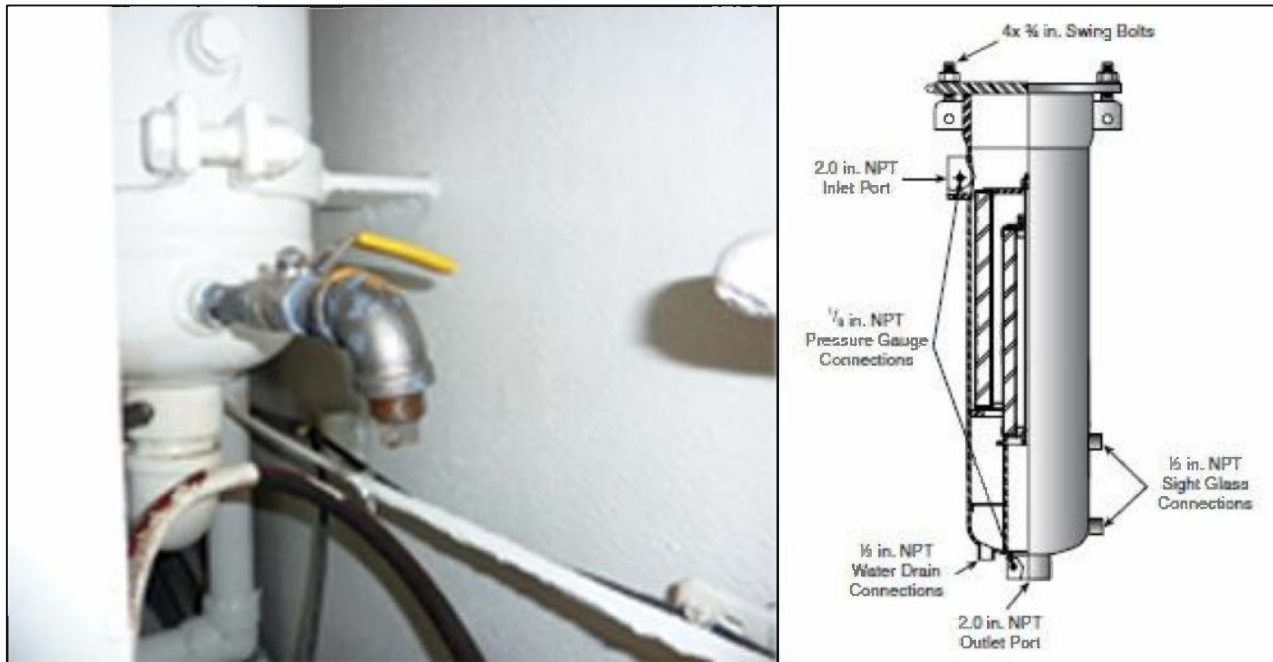


Photo 3 - Main Engine Primary RVFS-1 Filter Drain

C. Fuel Management Practices Contributed to Poor Fuel Quality.

- (1) The fuel oil service system was not operated in accordance with the approved design.
  - (a) In reference (c), the Chief Engineer indicated that there were no formal fuel management procedures in effect.
  - (b) Per references (r) and (s), the fuel oil service system is to be split at all times between the four fuel oil day tanks, with one main engine and one ship service diesel generator supplied by each day tank (see Figure 2). If operated in accordance with the references (r) and (s), the Worst Case Failure for the fuel oil service system (which is identified as day tank fuel oil contamination), would be limited to the loss of one main engine and one ship service diesel generator (notwithstanding cross contamination of day tanks via the fuel oil tank vent and overflow system discussed earlier).
  - (c) References (c), (e), and (f) show that two day tanks were used vice four.
    - i. In reference (c) the Chief Engineer stated that until 12/27/2012 all of the generators and main engines on the port side were supplied with fuel from the No. 1 Day Tank Port and the starboard generators and main engines were supplied by the No. 1 Day Tank Stbd. Further, the Chief Engineer indicated that the vessel was never operated using the four day tank configuration of the approved design.
    - ii. While operating with two fuel oil day tanks, contamination of one day tank can result in loss of two main engines and two ship service diesel

generators. Operating with two fuel oil day tanks vice four fuel oil day tanks is not addressed in references (r) and (s). Failure modes related to this type of fuel oil system configuration exceed the fuel oil system Worst Case Failure defined in both Failure Modes and Effects Analyses (FMEAs).

- (d) An American Bureau of Shipping audit of the AIVIQ's Safety Management System (SMS) conducted between 02/28/2013 and 03/21/2013 found the vessel was not operating per reference (r). In reference (gg), the vessel's operator acknowledged that the vessel was not operating in accordance with reference (r).
- (2) No. 2 Day Tanks Port and Stbd were used as FO Storage Tanks
- (a) References (e) and (hh) contain multiple entries which document that the No. 2 Day Tanks were used as fuel oil storage tanks. In reference (c), the Chief Engineer states that No. 2 Day Tanks were used as fuel oil storage tanks. Reference (hh) shows fuel oil loaded on board directly into No. 2 Day Tanks without being purified. Part 4-6-4/13.5.1(d) of reference (v) requires service tanks to contain only fuel of a grade and quality that meets the specification required by the equipment manufacturer. Part 4-6-4/13.5.1(d) of reference (v) also requires a service tank is to be declared as such and not used for any other purpose.
- (3) In reference (c), the Chief Engineer stated he had a "good source" of fuel oil in reserve in No. 2 Day Tank Port. He testified, "I had one tank where I always, an old engineering habit is to always hold one tank with what I know is good fuel, 7500 gallon's worth, which was the No. 2 Port Day Tank."
- (a) Reference (hh) shows No. 2 Day Tank contents were a mixture of unpurified (i.e., loaded directly into day tanks) fuel that was bunkered from three different sources over a period of six months:
    - i. 06/24/2012: U.S. Oil & Refining Co., Tacoma, WA: 17,812 gallons added to No. 2 Port FO Day Tank (total on board 17,812 gallons); 17,813 added to No. 2 Stbd FO Day Tank (total on board 18,185 gallons).
    - ii. 08/22/2012: M/T AFFINITY, West of Barrow, AK: 17,207 gallons added to FO Day Tank No. 2 Port (total on board 20,836 gallons); 17,349 gallons added to FO Day Tank No. 2 Stbd (total on board 20,659 gallons).
    - iii. 09/30/2012: M/T AFFINITY, West of Barrow, AK – 19,001 gallons added to FO Day Tank No. 2 Port (total on board 20,901 gallons); 18,975 gallons added to FO Day Tank No. 2 Stbd (total on board 20,901 gallons).
    - iv. 12/20/2012 Delta Western, Dutch Harbor, AK - 15,904 gallons added to FO Day Tank No. 2, (total on board 20,901 gallons); 14,244 gallons added FO Day Tank No. 2 Stbd, (total on board 20,901 gallons).

- (b) Reference (t) indicates that, on the night of 12/27/2012, No. 2 Day Tank Port contained approximately 3300 gallons and was filled to approximately 6300 gallons from FO # 3-Port and FO #3-Stbd. Reference (t) indicates that No. 2 Day Tank Port was filled at a rate that significantly exceeded the purifier's rated output. This suggests that the fuel may have been transferred directly into the day tank using the fuel oil transfer pump, rather than the purifier.
  - (c) Reference (e) shows the crew changed main engine and ship service diesel generator fuel supply to No. 2 Day Tank Port on 12/28/2012 after No.1 Day Tanks were determined to be contaminated. Some of the fuel oil in No. 2 Day Tank Port had been loaded as early as 06/24/2012. Any water that may have accumulated in No. 2 Day Tank Port (e.g., from condensation) during this period would have made the fuel oil susceptible to biological growth.
- (4) Both settling tanks were routinely filled from the same fuel oil sources. References (c), (e), (f), and (t) show the settling tanks were filled simultaneously. Reference (ii) shows the fuel oil transfer system has one common main. Transferring fuel to both settling tanks simultaneously will result in the same fuel oil being provided to both settling tanks. By not segregating the fuel oil supply to each settling tank, one contaminated fuel oil storage tank could contaminate both settling tanks.
- (5) Insufficient preventative measures were taken to prevent fuel oil contamination.
- (a) In reference (jj), the 1st Asst. Engineer stated that the crew did not regularly check fuel oil for water.
  - (b) In reference (k) the engine manufacturer recommends draining the fuel oil day tanks and engine filter/separators of water and sediment daily. Review of references (c), (e), (f), (hh), and (jj) revealed no indication that this practice was being followed.
  - (c) In reference (c), the Chief Engineer indicated that no additives were on board and no additives were used to prevent biological contamination of the fuel oil. References (i) (j), and (m) indicate biological contamination of the fuel at the time of the casualty. Reference (kk) recommends that all fuel on board be dosed with biocide at the first sign of microorganism contamination. There appear to have been no means on board to test for or respond to fuel oil biological contamination.
- (6) References (c), (e) and (f) indicate the only means on board for testing fuel oil was water gauging paste (e.g., Kolor Kut).
- (a) Kolor Kut Product Co., Ltd. instructions identify that Kolor Kut water gauging paste is used on sounding bobs, rods, or lines to detect the water level in tanks. Reference (h) shows no sounding tubes installed in the fuel oil settling tanks. If no sounding tubes were installed in the fuel oil settling tanks, there would be no feasible means to use water gauging paste to accurately check the settling tanks for water.

- (b) Ultra Low Sulfur Diesel Fuel is highly hygroscopic (i.e., readily absorbs water). As noted earlier, CAT fuel specifications in reference (k) require water content to be a maximum of 0.05%. It appears there were no means available for the crew to check fuel oil samples taken from the settling or day tank drains for water content (i.e., water dissolved in the fuel oil). Water gauging paste (e.g., Kolor Kut) can't be used to determine the amount of water absorbed in fuel oil.
- (7) We noted several conflicts between vessel and equipment design data, and the Chief Engineer's testimony and log entries regarding the vessel and its equipment.
- (a) In reference (c), the Chief Engineer testified that the main engines had good fuel pressure and normal fuel filter differential pressures prior to the failure of all main engines. It appears the Chief Engineer incorrectly assumed that water in the fuel would cause high differential pressure in the fuel filters. In reference (ll), the filter manufacturer identified that, if the RVFS-1 primary filter accumulated water, there would be no significant increase in differential pressure before the water would be passed through the RVFS-1 filters to the engines.
  - (b) In reference (c), the Chief Engineer states that fuel oil day tank suction for main engine and ship service diesel generator fuel oil supplies were installed 30-inches from the bottom of the day tanks to prevent water from entering the fuel oil supply to the engines. As indicated earlier, reference (g) shows engine fuel oil suction 1 inch from the bottoms of the day tanks, at the same height from the tank bottoms as the day tank drains.
  - (c) Some engineroom log entries indicate either poor recordkeeping, or perhaps a basic misunderstanding of tank capacities.
    - i. Reference (e) shows 15,509 gallons of fuel oil transferred from fuel oil Storage Tank #2 Center to the Settling Tanks on 12/27/2012. References (x) and (hh) show the capacity of #2 Center FO Storage Tank is only 13,257.7 gallons (at 100% capacity). Further, there is no indication from reference (t) that any fuel was transferred from fuel oil Storage Tank #2 Center on 12/27/2012. Reference (t) shows that on 12/27/2012 fuel was transferred from FO #3-Port (7,256 Gallons), FO #3-Stbd (8,478 gallons), FO #6C-Port (5,383 gallons), and FO #6C-Stbd (2,254 gallons).
    - ii. Reference (e) shows 66,092 gallons of fuel oil transferred from FO Storage Tank "#1 P/S" to the Settling Tanks between 12/23/2012 and 12/25/2012. References (x) and (hh), however, show FO Storage Tanks #1 DB-Port and #1 DB-Stbd have a combined capacity of only 51,047.6 gallons (at 100 % capacity).
  - (d) The Chief Engineer's description of the fuel oil vent design is inconsistent with the installed arrangement. In reference (c), the Chief Engineer identifies that wafers and springs within the vents prevent the influx of water when the vents are submerged. According to reference (mm), however, the installed vents

have only one moving part, a plastic circular float. Photo 4, provided in reference (nn), shows a typical fuel oil system vent installed aboard AIVIQ.



Photo 4 - Fuel Oil Overflow Vent (Typical)

### 3. Summary

- A. AIVIQ's loss of main propulsion engines was likely due to fuel oil contamination by seawater.
- (1) Subsequent tests performed on a sample of fuel loaded aboard AIVIQ at Delta Western on 12/21/2012 revealed no indication of water or seawater contamination. The fuel sample met all specifications. It did, however, exhibit an unusual and unexplained characteristic wherein a stable emulsion formed when the fuel was mixed with fresh water or seawater.
  - (2) Based on numerous log entries regarding replacement of main engine and ship service diesel generator injectors and clogged fuel oil flowmeters, it appears that the vessel had experienced fuel quality problems for months prior to the casualty.
  - (3) Water contamination was first noted in engineering logs in the hours preceding the casualty. All four main engines failed over a period of approximately four hours.
  - (4) Tests performed after the casualty indicate that seawater was present in the Settling Tanks, No.1 Day Tanks, Main Engine Primary Filters, and Main Engine injectors.
  - (5) Extensive corrosion was found on Main Engine and Ship Service Diesel Engine injector internal parts. From the extent of corrosion present, it is possible that fuel oil could have been contaminated with water and/or seawater, at least to some extent, for more than just a few days prior to the casualty.
- B. Certain aspects of AIVIQ's engineering design do not appear to comply with the intent of classification and/or regulatory standards. At minimum, in our opinion, these aspects of the design did not represent good marine practice, and likely increased the potential for seawater contamination of fuel oil. Further, these design features likely reduced the crew's ability to prevent, detect and respond to fuel contamination when it did occur.

- (1) The common vent and overflow system aboard AIVIQ appears to have allowed seawater contamination of the fuel oil settling and day tanks, leading to the loss of main propulsion in rough sea conditions. Logs indicate problems, including clogging and overflow alarm conditions, with the fuel oil vent and overflow system in the months leading up to the casualty. These problems could have led the crew to become complacent about the overflow alarm, allowing seawater to accumulate in the FO Overflow Tank. Once the FO Overflow Tank was full, any further seawater entering the vent/overflow system would collect in the common fuel oil vent/overflow headers, where it could contaminate fuel oil tanks. The common vent and overflow configuration was not addressed in the vital system automation (ACCU) FMEA or the Dynamic Positioning System FMEA. Cross connection of the fuel oil storage, settling and day tanks could result in a much more severe fuel oil system Worst Case Failure than is defined in these FMEAs.
- (2) There were inadequate means provided to regularly check the settling tanks for water and/or sediment or to remove it if present. Drain valves were too small to permit removal of a significant quantity of water from the tanks. In addition, there was no means provided to collect tank drainage.
- (3) The configuration of the fuel oil day tank engine supply suction and drains provided inadequate means for the crew to remove any accumulated water or sediment before it could be drawn into the engine. There were inadequate means to regularly drain the day tanks of water and/or sediment. Drain valves were too small to permit removal of a significant quantity of water from the day tanks. The length of the drain pipe further increased the potential for water in the day tank to go undetected. In addition, there were no means provided to collect day tank drainage.
- (4) The fuel oil purifier piping arrangement provided no effective means for responding to fuel oil day tank contamination, as it lacked the ability to recirculate and purify fuel oil in the day tanks.
- (5) Main engine fuel oil filters are required to be arranged such that they can be cleaned without interrupting the fuel supply to the engine (e.g., duplex filter, or two filters in parallel, etc.). Since only one primary fuel oil filter was installed for each main engine, there was no means to service the filters without securing the corresponding main engine. Further, the fuel oil filter drains were not installed in the drain port provided, but rather installed in the filter's lower sight glass port, an arrangement that precluded full drainage of any water that might accumulate in the filter body. Other than the installed drain, there was no means to detect the presence of water in the filter without opening it, as it was not provided with a sight glass or water monitoring probes and associated alarms. According to the manufacturer, the crew's practice of monitoring filter differential pressure was an ineffective means for detection of water.

C. On board fuel management practices likely contributed to the casualty.

- (1) The crew did not routinely check fuel oil for the presence of water. It appears that the crew did not regularly drain the settling tanks, day tanks and primary filters for water. There were limited means on board to check for water in the fuel oil.

- (2) There was a lack of formal fuel management practices on board the AIVIQ.
- (3) The crew used the No. 2 FO Day Tanks as fuel oil storage tanks. On numerous occasions, bunkers were transferred directly to No.2 Day Tanks without purification.
- (4) The crew did not operate the vessel in accordance with the approved FMEAs, in that they used only one pair of fuel oil day tanks to serve four main engines. This practice defeated the level of redundancy afforded by the design approved in the FMEAs. The FMEAs require each day tank to be configured to supply one main engine and one ship service diesel generator to limit the fuel oil system Worst Case Failure (contaminated day tank) to the loss of one main engine and one ship service diesel generator.
- (5) Crew testimony and other evidence indicate that there was a general lack of familiarity with certain aspects of the engineering design and intended operation. This unfamiliarity relates to key details concerning the vessel's fuel tank capacities, the fuel oil day tank suction arrangement, the design and operation of fuel oil vents, and means to detect the presence of water (e.g., limitations on the use of water gauging paste, and reliance on main engine primary filter differential pressure to indicate presence of water, etc.).

**References**

- (a) DNV Petroleum Services, Fuel Analysis Report HOU1321074 dated 08/31/2013.
- (b) DNV Petroleum Services, Fuel Analysis Report HOU1321074 dated 09/13/2013.
- (c) USCG Exhibit 58, C/E [REDACTED] Transcript.
- (d) ULSD2 Certificate of Quality/Tanker AFFINITY Shell 007484 – 007499.
- (e) AIVIQ Engineeroom Smooth Logs K003123-K003368.
- (f) AIVIQ Engineeroom Rough Logs K003701-K004031.
- (g) North American Shipbuilding, Dwg No. M2, Rev (A2), Fuel Oil Service System.
- (h) North American Shipbuilding, Dwg No. M26, Rev (A1), Tank Level Indication System.
- (i) DNV Petroleum Services, Fuel Analysis Report HOU1319037 dated 08/14/2013.
- (j) DNV Petroleum Services, Fuel Analysis Report HOU1319041 dated 08/14/2013.
- (k) Caterpillar Commercial Diesel Engine Fluids Recommendations SEBU6251-13.
- (l) Shell AIVIQ Partial FO Analysis Shell-007598.
- (m) Shell AIVIQ Partial FO Analysis Shell-007599.
- (n) AIVIQ Engineeroom Rough Log K013732.
- (o) Southwest Research Institute, “Preliminary Findings for Failed Edison Chouest Offshore Shipboard Fuel Injectors”, dated 02/18/2013.
- (p) Caterpillar, C280 Injector Failure – AIVIQ, undated.
- (q) North American Shipbuilding, Dwg No. M24, Rev (B2), Fuel Oil Overflow System.
- (r) Edison Chouest Offshore, Dwg No. 73121958, Rev (B), AIVIQ Preliminary ACCU Qualitative FMEA & DVTP.
- (s) Edison Chouest Offshore, Dwg No. 68832295, Rev (B), AIVIQ DP FMEA.
- (t) AIVIQ Hourly Tank Level Indicator Data, USCG Exhibit 073.
- (u) AIVIQ Engineeroom Rough Logs K013710-K013731.
- (v) American Bureau of Shipping, Rules for Building and Classing Steel Vessels 2009.
- (w) USCG Sector Seattle e-mail dated 08/15/2013.
- (x) North American Shipbuilding, Dwg No. 72633933, (3), AIVIQ Trim & Stability Manual.
- (y) North American Shipbuilding, Dwg No. D2, Rev (-), General Arrangement.
- (z) Caterpillar, “Diesel Fuel and Diesel Fuel Systems”, LEBW4976-04)
- (aa) Alfa Laval, Heatpac EHS-61, -62 Electric Heating Systems, Pub No. EMD00043EN.
- (bb) Alfa Laval, Technical Data MMB 305 S-11 Separation System, Pub No. 1810670-02.
- (cc) AIVIQ Engine Alarm Data K004190-K004323.
- (dd) Caterpillar C280-12 Diesel Engine Technical Data, DM8408-00, dated 01/16/07.
- (ee) Racor, RVFS Vessel Series Installation, Operation and Service Manual RAC 1-92.
- (ff) Email from Mr. [REDACTED] Marker Manager Oil & Gas, from Parker Hannifin Corporation (Racor OEM) to [REDACTED] USCG Marine Safety Center, dated 10/16/13.
- (gg) Galliano Marine Service, AIVIQ Corrective Action Request IACS PR 17 Notification, Report Nr. S2304593.R2, dated 03/21/2013)
- (hh) AIVIQ Oil Record Book, Evidence Control No. 4572894-003
- (ii) North American Shipbuilding, Dwg No. M3, Rev (A4), Ship’s Fuel Oil Transfer System.
- (jj) Interview AIVIQ 1st Asst Engineer [REDACTED] Sector Anchorage, 01/13/2013.
- (kk) Caterpillar Marine Engines Application and Installation Guide, LEKM7147-01.
- (ll) Email from Mr. [REDACTED] Marker Manager Oil & Gas, from Parker Hannifin Corporation (Racor OEM) to [REDACTED] USCG Marine Safety Center, dated 10/15/13.
- (mm) [REDACTED] AS, “Maritime Tank Venting Technique”, General Brochure.
- (nn) USCG Sector Seattle e-mail dated 09/23/2013.